

NL Installatievoorschrift
BE Kookplaten

GB Installation instructions
Hobs

DE Installationsanleitung
Kochfeld

FR Instructions d'installation
BE Plaque de cuisson



Dit toestel mag alleen door een erkend installateur worden aangesloten. Lees de veiligheidsvoorschriften.
The fitting of the appliance should only be carried out by a registered and qualified installer. Please read the safety regulations.
Cet appareil ne peut être installé que par un technicien gazier agréé. Lisez les instructions de sécurité.
Dieses Gerät darf nur von einem anerkannten Installateur angeschlossen werden! Bitte lesen Sie die Sicherheitsbestimmungen.

Vorbereidingen voor montage/Preparations for installation
Préparation avant installation/Vorbereitung der Montage

Gebruikte pictogrammen/Pictograms used
Pictogrammes utilisés/Verwendete Piktogramme



Belangrijk om te weten/Important information
Important à savoir/Wichtig zu wissen



Elektrische aansluiting/Electrical connection
Branchement électrique/Elektrische anschluss

KIV354RVS

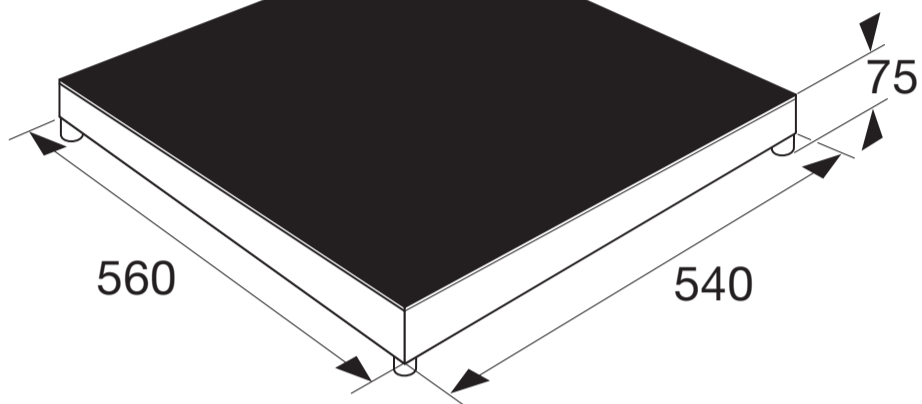

PKI260RVS
KIV360WIT

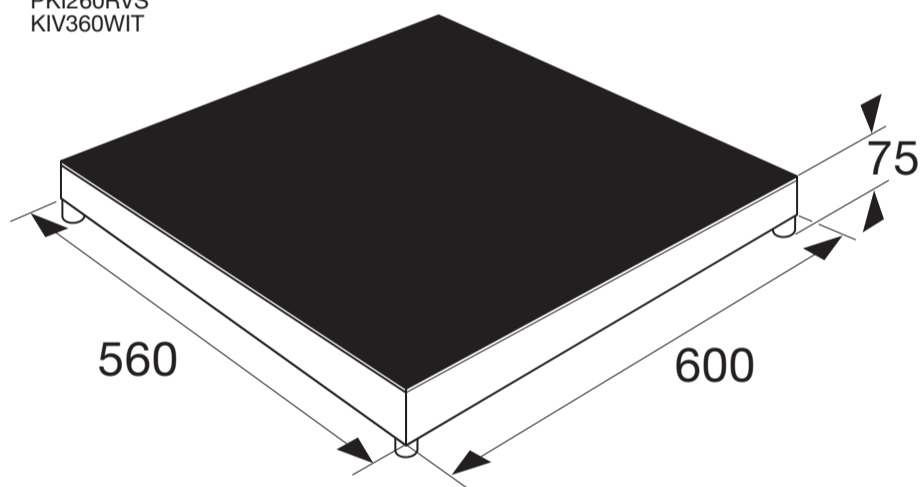

Dit toestel moet altijd geaard zijn.
This appliance must be earthed.
Cet appareil doit être mis à la terre.
Dieses Gerät muß jederzeit geerdet sein.

De elektrische aansluiting moet voldoen aan de nationale en lokale voorschriften.
The electrical connection must comply with national and local regulations.
Le branchement électrique doit satisfaire aux prescriptions nationales et locales.
Der elektrische Anschluß muß den nationalen und kommunalen Vorschriften entsprechen.

Aansluitwaarden/Connected load/Charge connectée/Anschlussleistung

| | L1 (W) | L2 (W) | L3 (W) | Total load (W) |
|-----------|--------|--------|--------|----------------|
| PKI260RVS | 3680 | 3680 | 0 | 7360 |
| KIV360WIT | 3680 | 3680 | 0 | 7360 |
| KIV354RVS | 3680 | 3680 | 0 | 7360 |

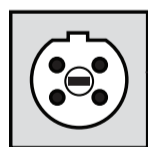

$v = ?$

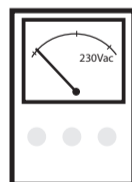

2-2N 230V 50Hz
2x 16A



Kookgroep aansluiting!

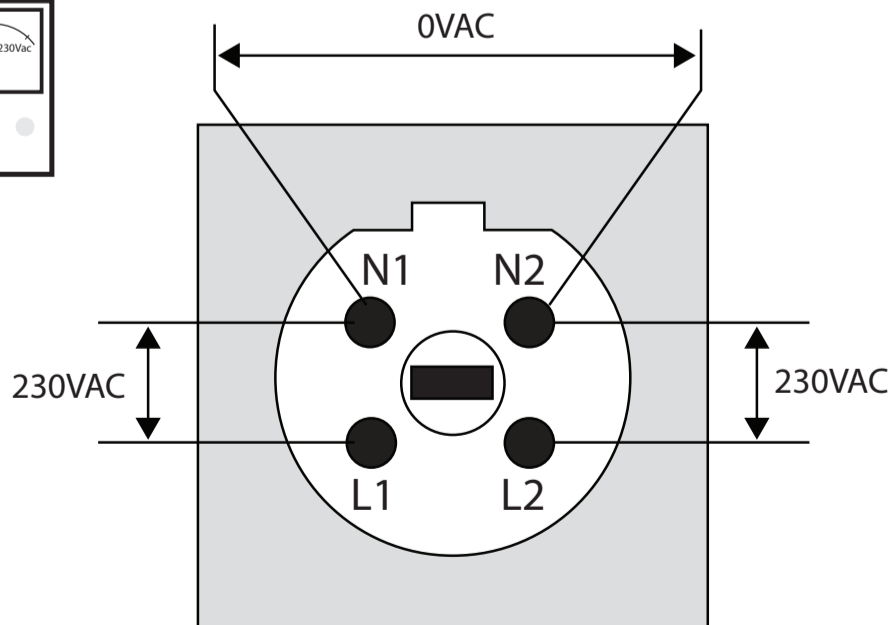
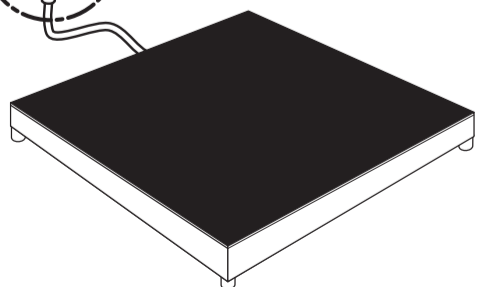



Elektrische aansluiting/Electrical connection
Branchement électrique/Elektrische anschluss

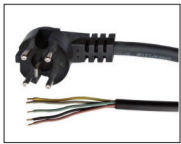

2-2N 230V 50Hz

NL

2-2N 230V 50Hz - 2x 16A
 2 fase - 2 nullen / 2 phases - 2 neutral
 2 Phasen - 2 Nullanschlüsse / 2 phases et 2 neutres

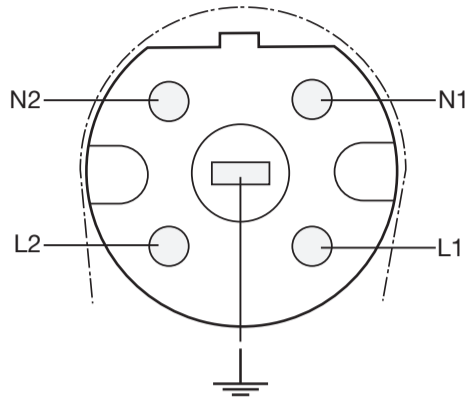

Aderdoorsnede
 Cross sectional area
 Fil diamètre
 Aderquerschnitt

5x1,5mm² (<2m)

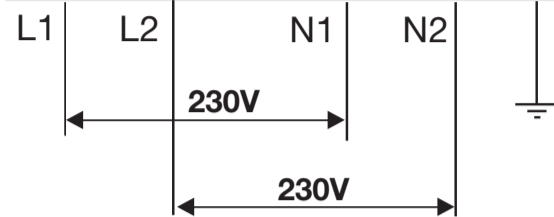

De 2 fasen van de kookgroep-automaat moeten door 1 aardlekschakelaar gevoed worden.
 Het is niet toegestaan om L1/N1 via een andere aardlekschakelaar te laten lopen dan L2/N2

De elektrische aansluiting wijzigen/Changing the electrical connection
Changer la branchement électrique/Ändern der elektrischen anschluss

Raadpleeg de aansluitschema's op de onderzijde van het toestel/Maak de nodige doorverbindingen op het aansluitblok!

Consult the wiring diagrams on the bottom of the appliance/Make the required connections on the connecting block.

Consultez les schémas de raccordement situés en bas l'appareil/Effectuez les connexions nécessaires sur le bloc de raccordement !

Beachten Sie das Anschlussdiagramm auf der Unterseite des Geräts/Stellen Sie die erforderlichen Anschlussverbindungen am Anschlussblock her!

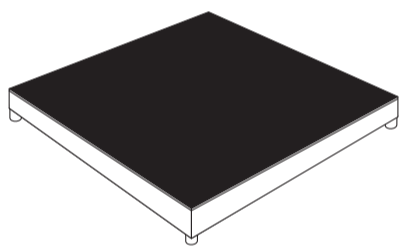

180°

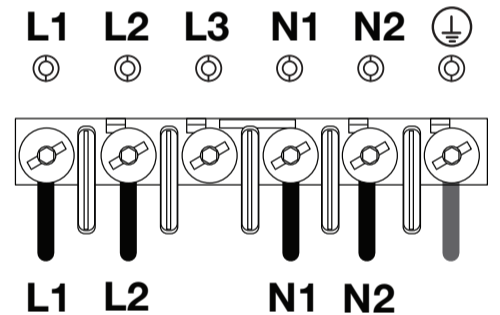
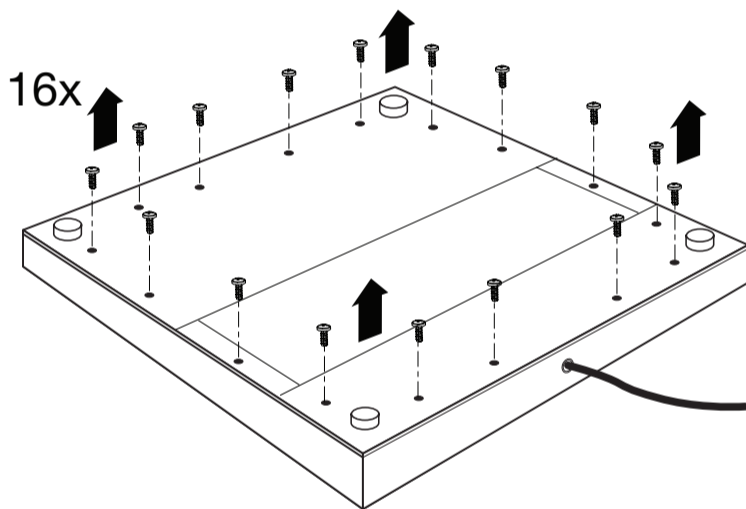

BE/NL

2N 380-415V 50/60Hz - 2x 16A
 2 fase - 1 nul / 2 phases - 1 neutral
 2 Phasen - 1 Nullanschluss / 2 phases et 1 neutre

Aderdoorsnede
 Cross sectional area
 Fil diamètre
 Aderquerschnitt

4x1,5mm² (<2m)

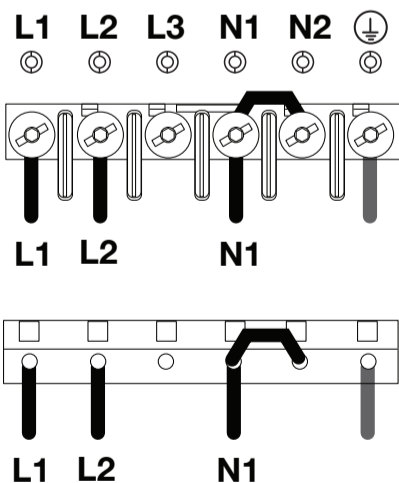
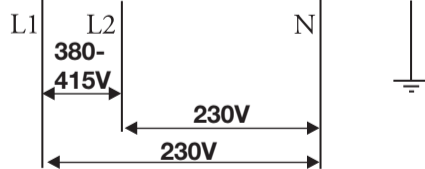

BE

1 1N 230V 50/60Hz - 1x 32A
 1 fase - 1 nul / 1 phase - 1 neutral
 1 Phase - 1 Nullanschluss / 1 phase et 1 neutre

Aderdoorsnede
 Cross sectional area
 Fil diamètre
 Aderquerschnitt

3x4 mm² (<2m)

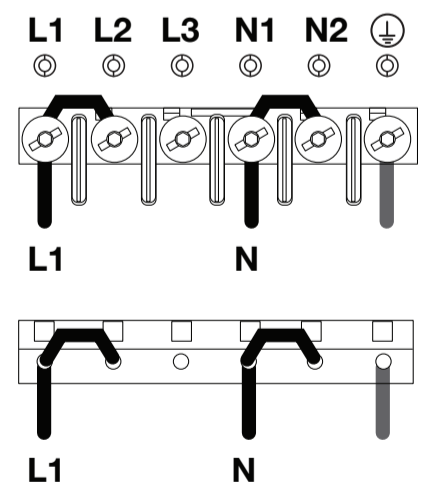

801901