

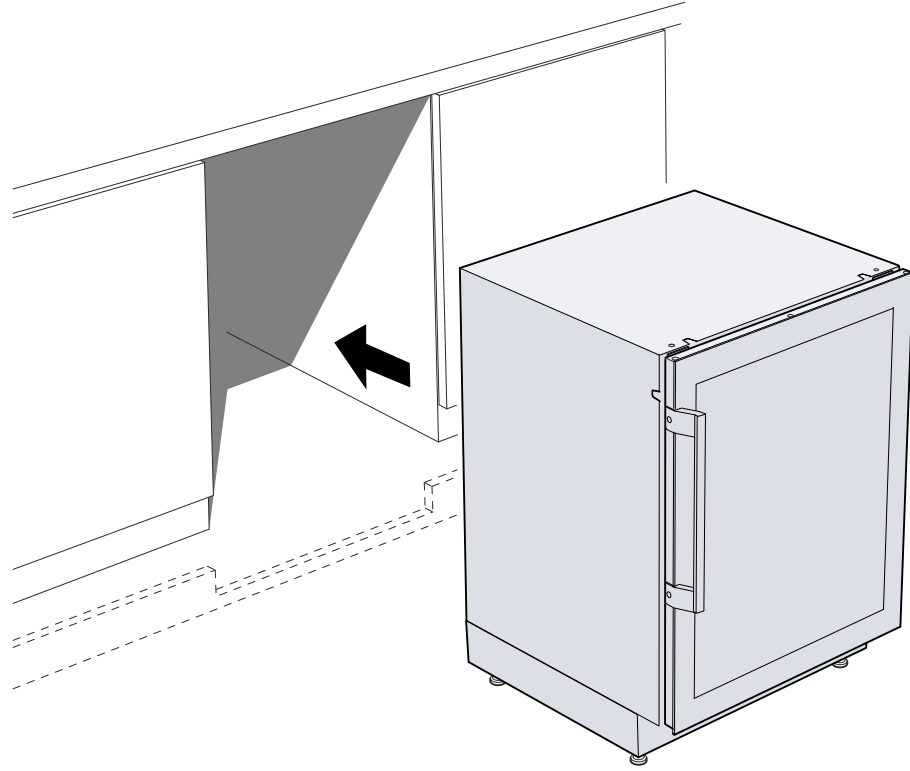

9001581603 (060223)



mm



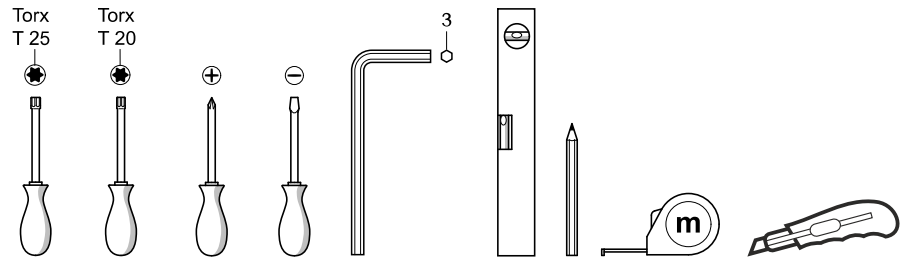
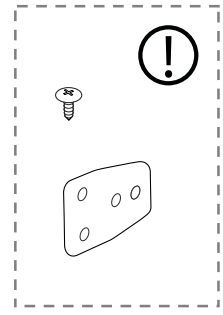
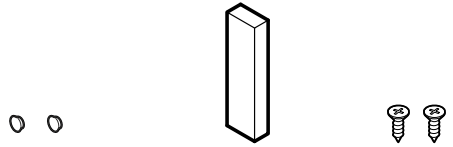
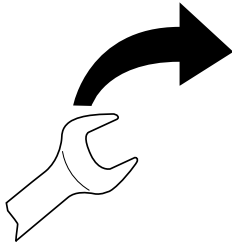
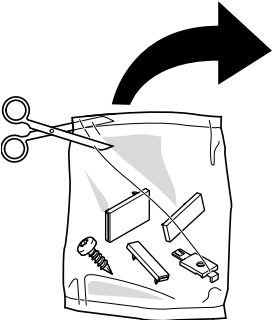

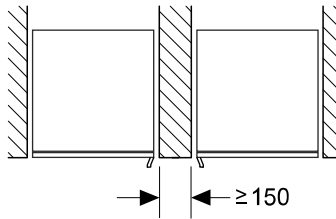
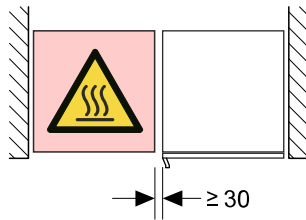
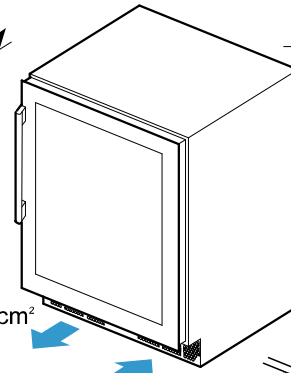
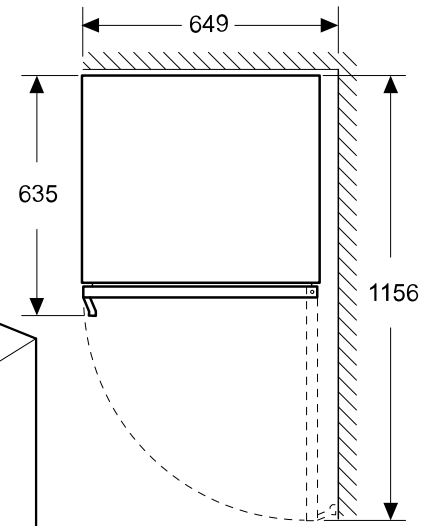
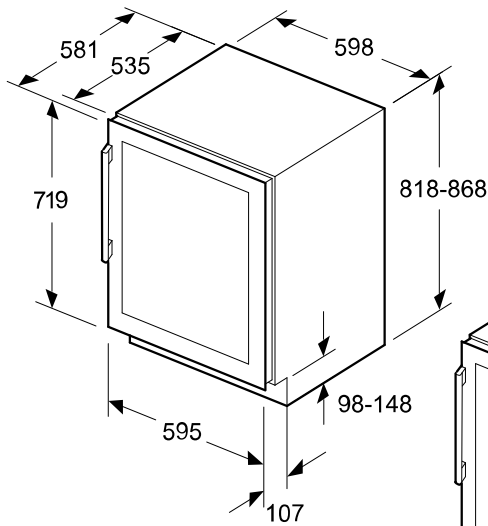
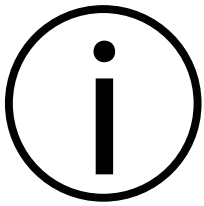

$\geq 80\text{cm}^2$

$\geq 80\text{cm}^2$

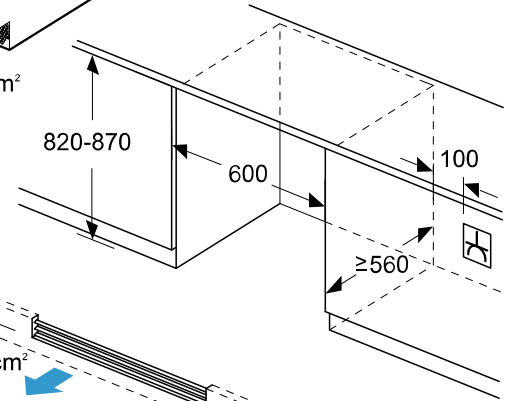

$\geq 80\text{cm}^2$

$\geq 80\text{cm}^2$

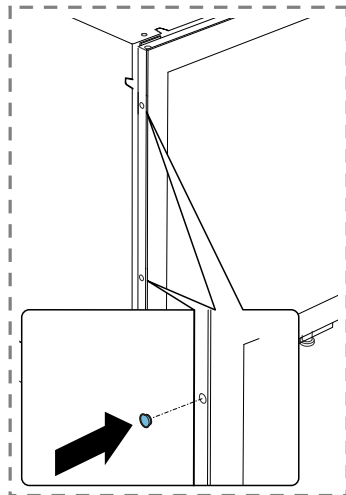
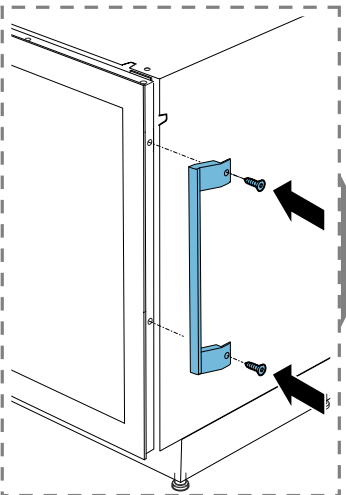
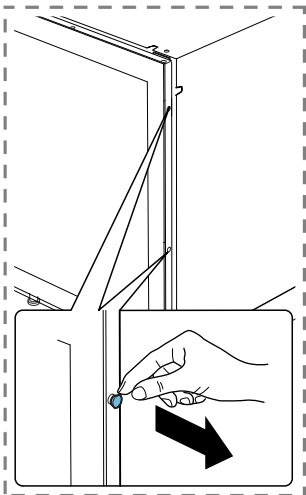
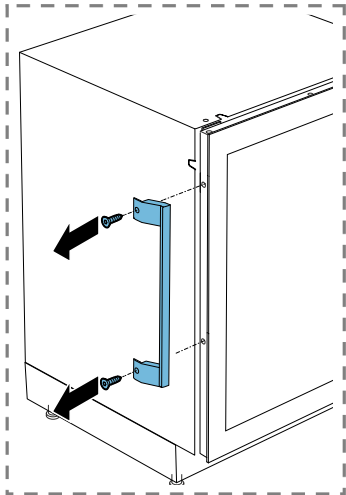
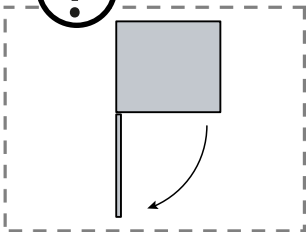
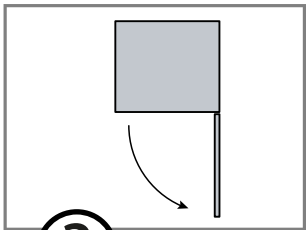

Torx
T 25



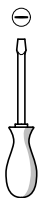
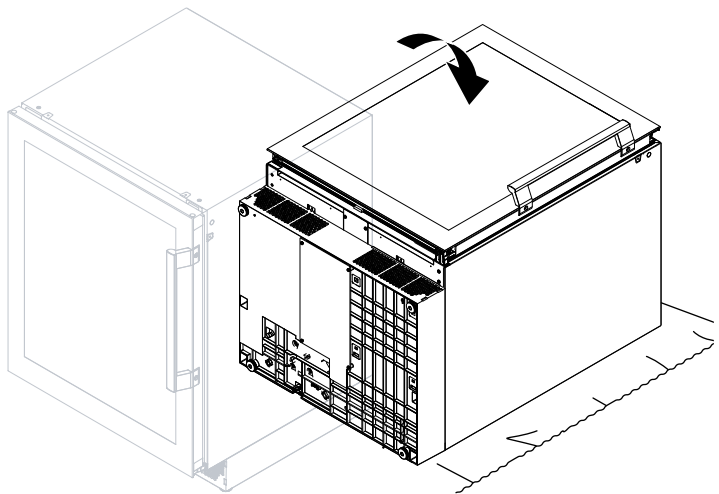
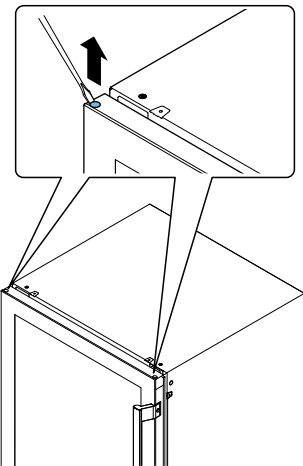
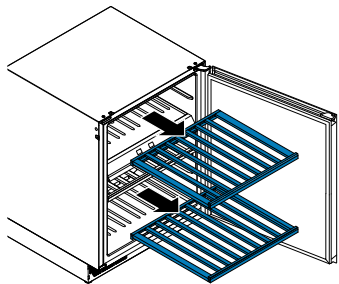
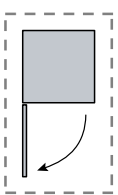

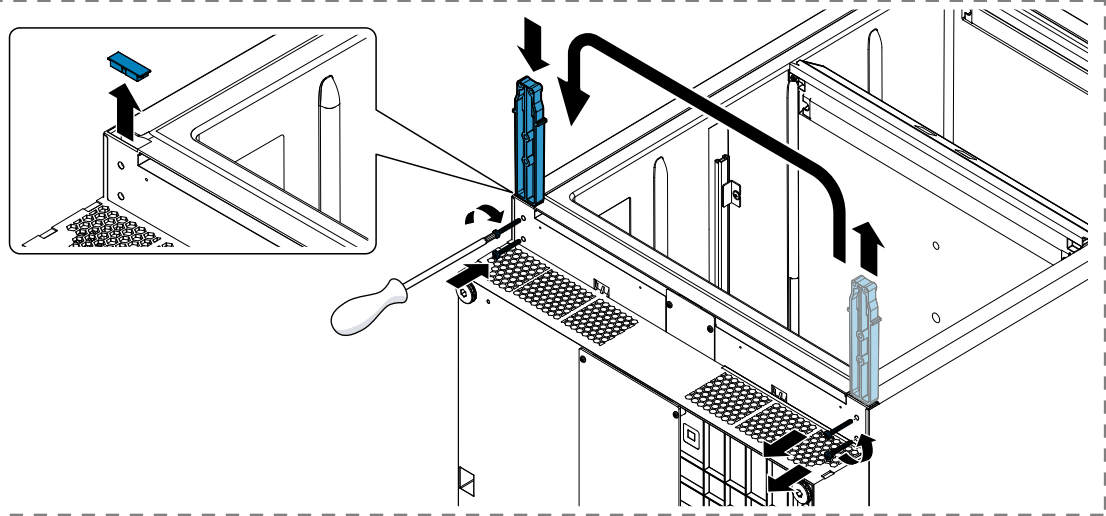
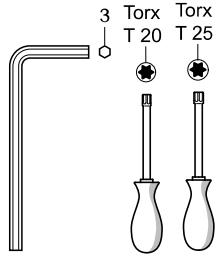
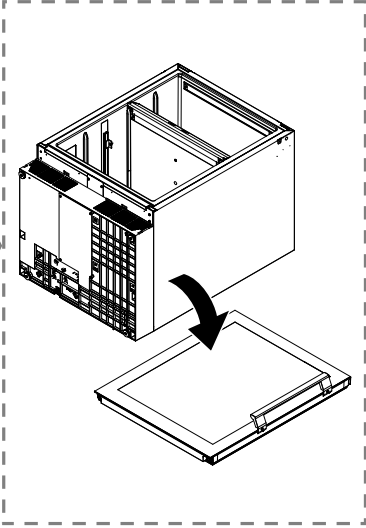
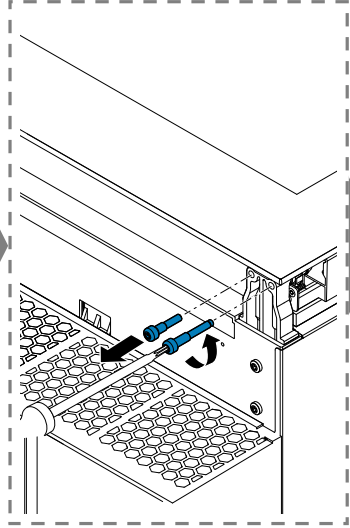
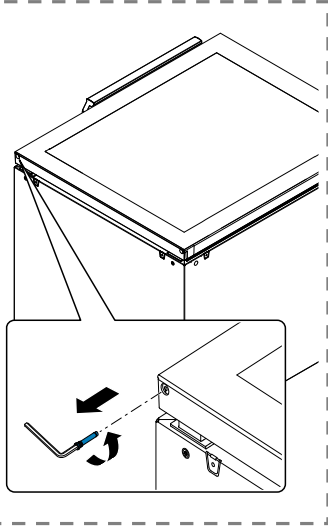
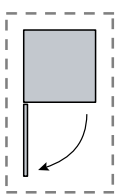

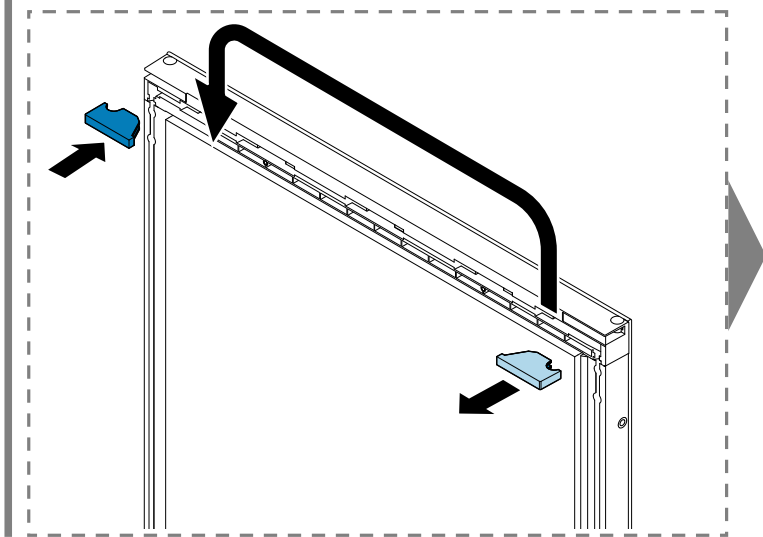
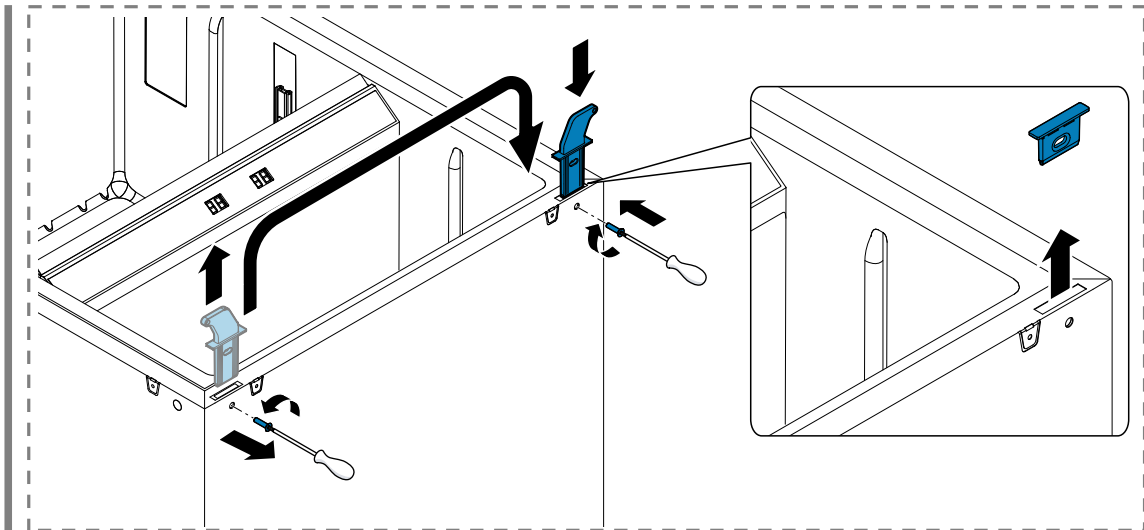
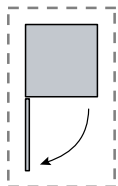

Torx
T 25



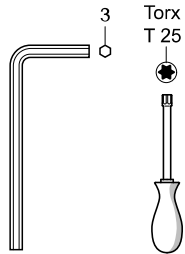
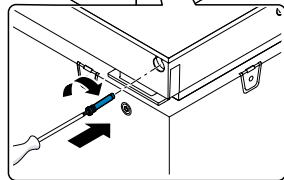
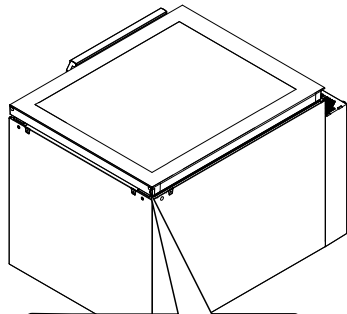
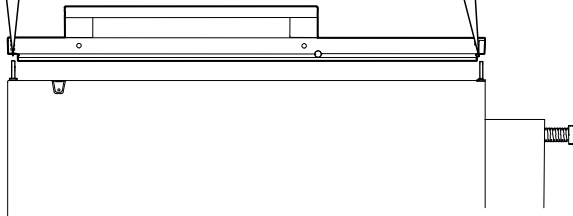
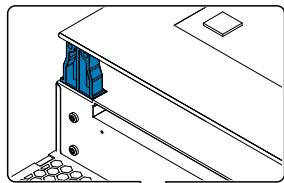
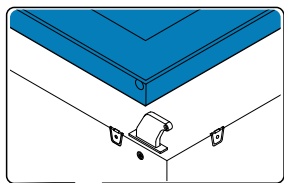
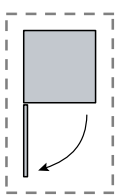

3

Torx
T 25

2,7 Nm

