

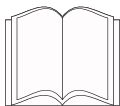

**de** Montageanleitung  
**en** Installation instructions  
**fr** Notice d'installation  
**nl** Installatie-instructies  
**it** Istruzioni d'installazione  
**el** Οδηγίες εγκατάστασης  
**es** Instrucciones de montaje  
**pt** Instruções de instalação  
**sv** Installationsanvisningar  
**no** Installasjonsveiledning  
**fi** Asennusohjeet  
**da** Installationsvejledning  
**tr** Kurulum talimatları  
**ru** Инструкция по установке  
**cs** Pokyny k instalaci  
**pl** Instrukcje montażu  
**hu** Telepítési útmutató  
**hr** Upute za instalaciju  
**mk** Упатства за инсталирање  
**sl** Navodila za montažo

**sr** Uputstva za montažu  
**et** Paigaldusjuhised  
**lt** Įrengimo instrukcijos  
**lv** Uzstādīšanas instrukcijas  
**sk** Pokyny na inštaláciu  
**sq** Udhëzimet e instalimit  
**fa** دستورالعمل نصب  
**ar** تعليمات التركيب  
**ko** 설치 설명서  
**zh** 安装说明  
**uk** Інструкція з монтажу  
**ro** Instrucțiuni de instalare  
**bg** Инструкции за монтаж  
**ja** 設置説明書  
**he** הוראות התקנה  
**id** Petunjuk pemasangan  
**kk** Орнату нұсқаулықтар  
**zh-hk** 安裝說明  
**zh-tw** 安裝說明  
**uz** O'rnatish bo'yicha yo'riqnomalar





<b>de</b>	über den Kundendienst erhältlich	<b>sr</b>	može se dobiti preko korisničkog servisa
<b>en</b>	Available from our after-sales service	<b>et</b>	saadaval hooldekeskuse kaudu
<b>fr</b>	disponible via le service après-vente	<b>lt</b>	galima įsigyti klientų aptarnavimo tarnyboje
<b>nl</b>	bij de servicedienst verkrijgbaar	<b>lv</b>	var saņemt klientu apkalpošanas dienestā
<b>it</b>	disponibile presso il servizio di assistenza clienti	<b>sk</b>	dostupné prostredníctvom zákazníckeho servisu
<b>el</b>	διαθέσιμο από την υπηρεσία εξυπηρέτησης πελατών	<b>sq</b>	marrja e mundshme përmes shërbimit të klientit
<b>es</b>	disponible a través del Servicio de Atención al Cliente	<b>fa</b>	در مرکز خدمات مشتریان موجود است
<b>pt</b>	pode ser adquirido nos nossos Serviços Técnicos	<b>ar</b>	يمكن الحصول عليها من خدمة العملاء
<b>sv</b>	går att beställa via service	<b>ko</b>	고객 서비스센터를 통해 구입 가능
<b>no</b>	fås hos kundeservice	<b>zh</b>	可向客户服务索取
<b>fi</b>	saatavissa huoltopalvelusta	<b>uk</b>	Через сервісну службу
<b>da</b>	Fås hos kundeservice	<b>ro</b>	se pot obține de la serviciul de asistență pentru clienți
<b>tr</b>	müşteri hizmetlerinden temin edilebilir	<b>bg</b>	предоставя се от службата за обслужване на клиенти
<b>ru</b>	можно приобрести через сервисную службу	<b>ja</b>	カスタマーサービスを通じて入手可能
<b>cs</b>	k dostání v zákaznickém servisu	<b>he</b>	זמין דרך שירות הלקוחות
<b>pl</b>	do nabycia w punkcie serwisowym	<b>id</b>	Tersedia di Layanan Pelanggan
<b>hu</b>	a vevőszolgáltatón keresztül kapható	<b>kk</b>	сервистік қызмет арқылы алуға болады
<b>hr</b>	može se kupiti kod servisne službe	<b>zh-hk</b>	可向售後服務站索取
<b>mk</b>	достапно преку сервисната служба	<b>zh-tw</b>	可向客戶服務單位索取
<b>sl</b>	na voljo prek pooblaščenega servisa	<b>uz</b>	otishdan keyingi xizmat orqali olish mumkin

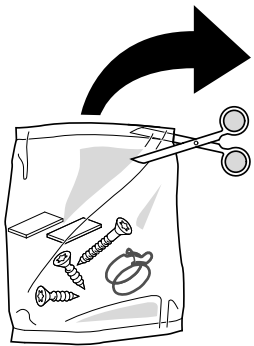

Ø4X36

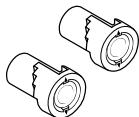
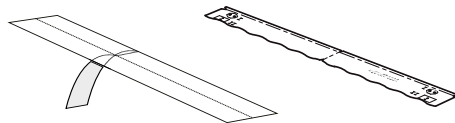
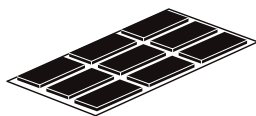

Ø4X15

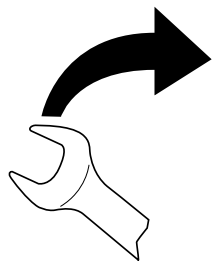
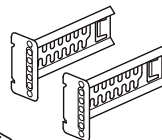
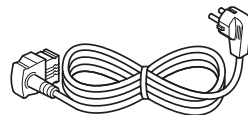
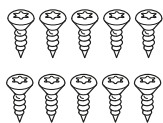

Torx  
T 15 T 20

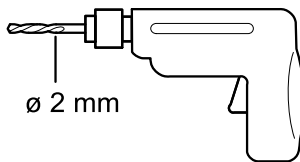
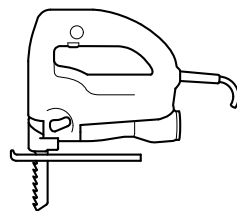
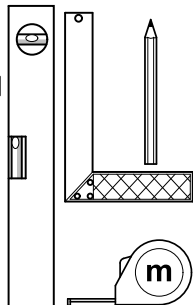
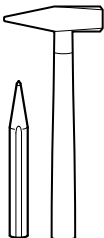
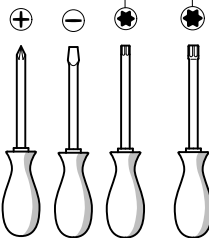

Ø 2 mm

SW13

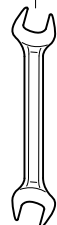

SW10

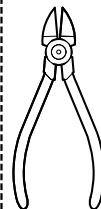
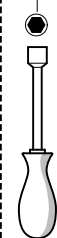

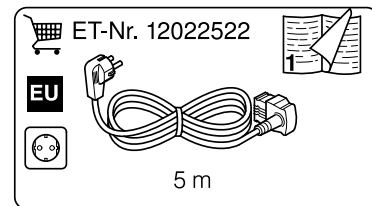
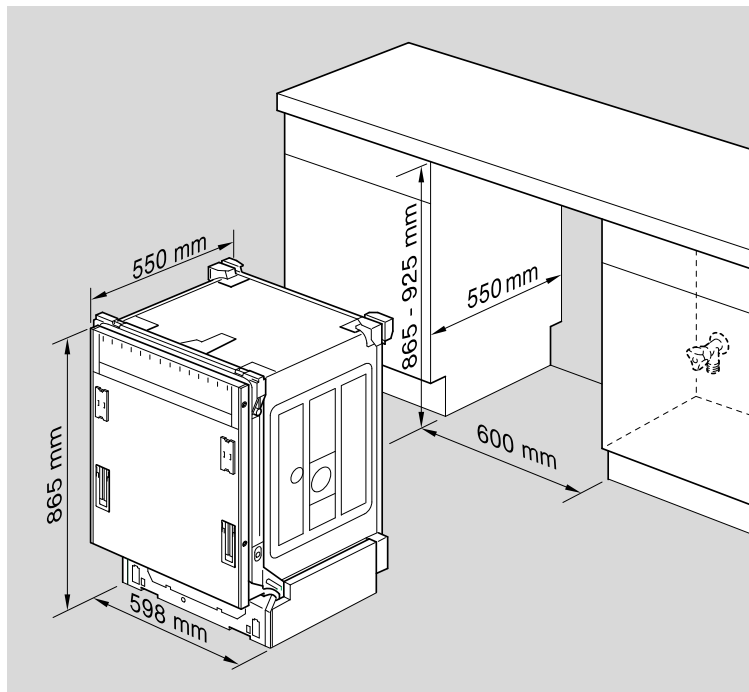
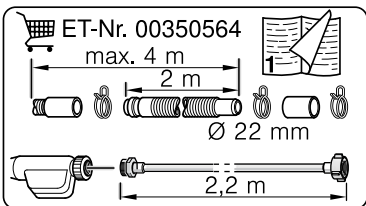
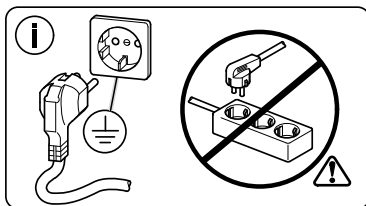
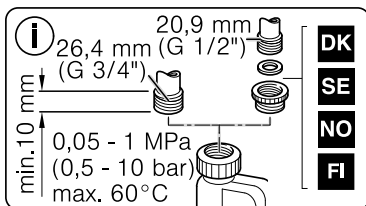
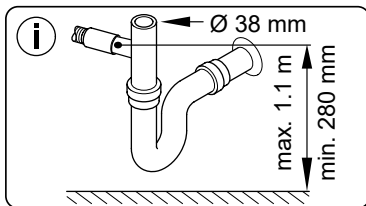

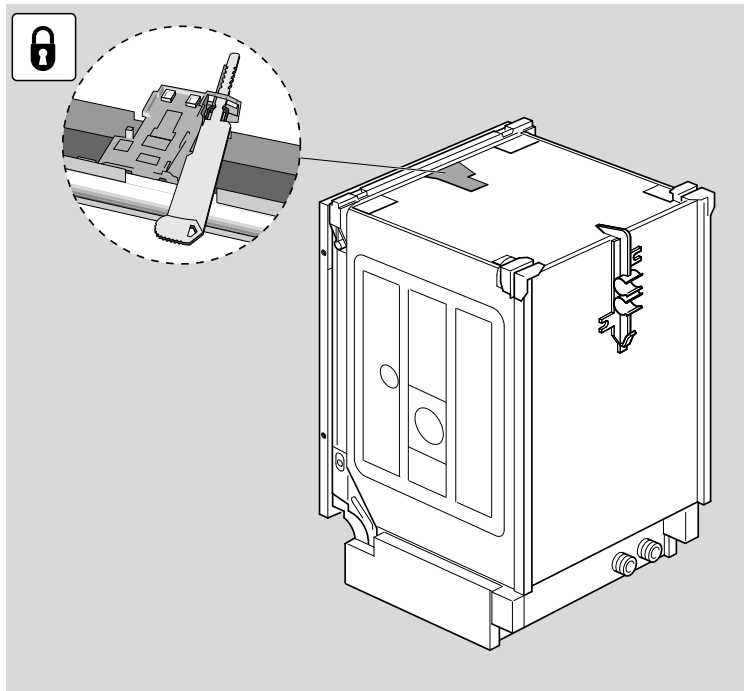
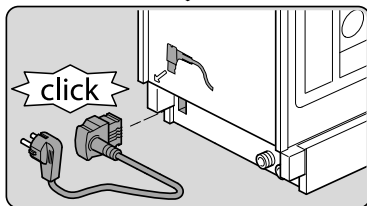
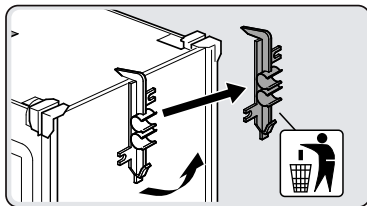
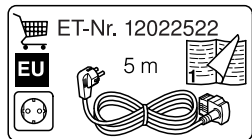
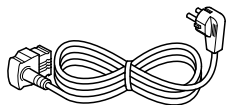

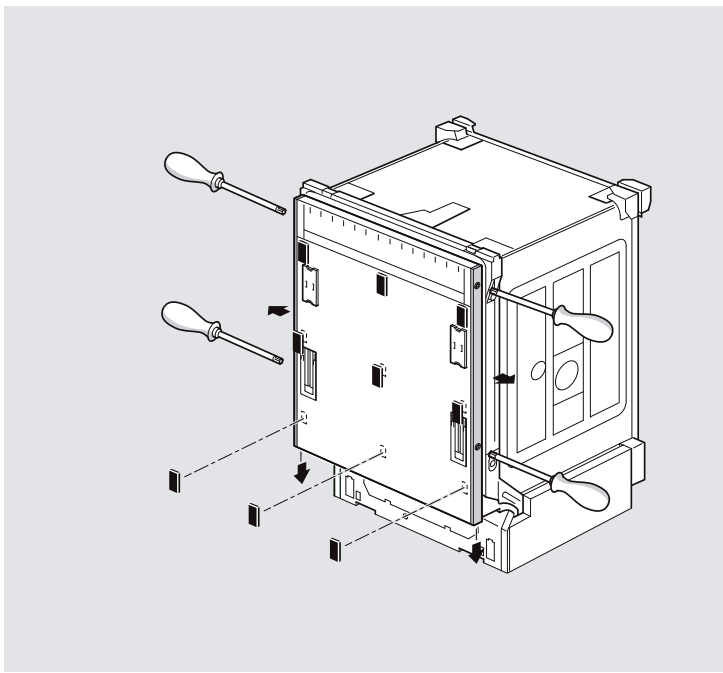
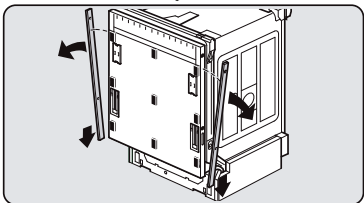
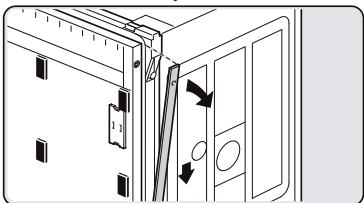
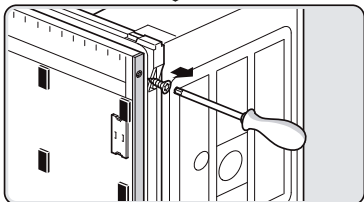
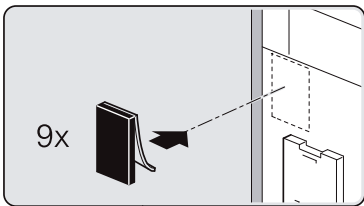
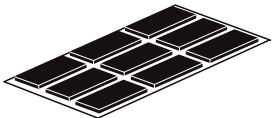

Torx  
T 15



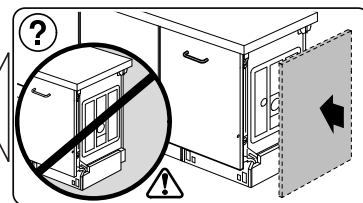
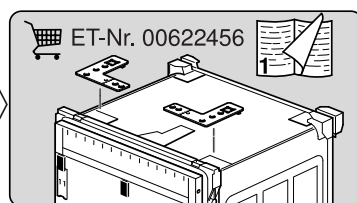
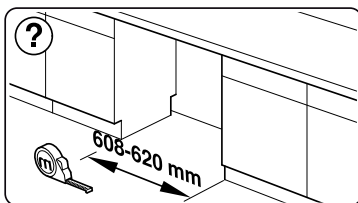
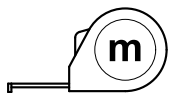
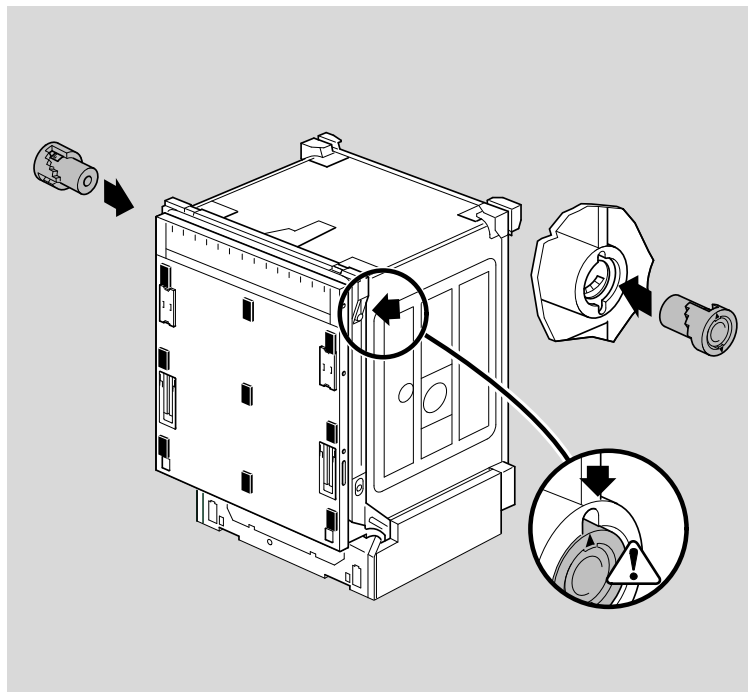
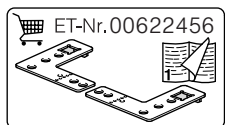
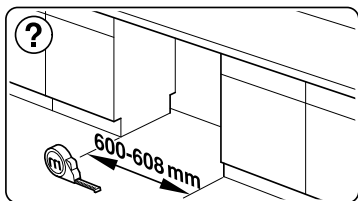
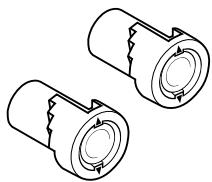

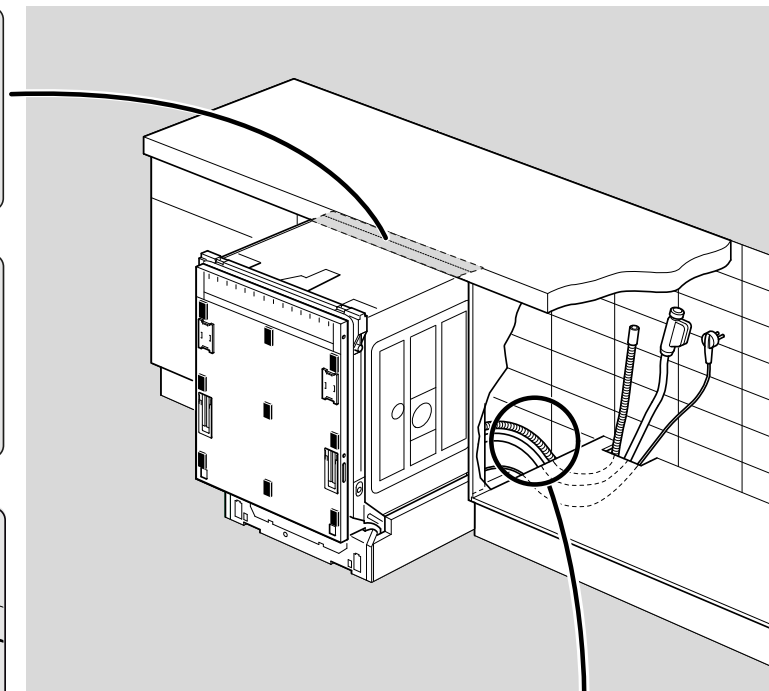
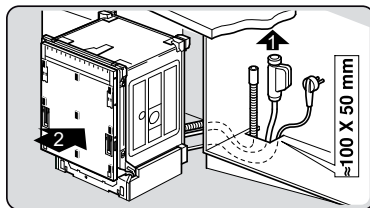
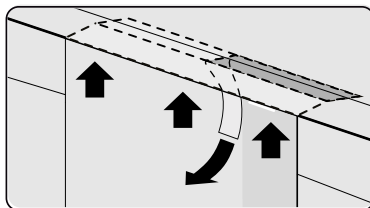
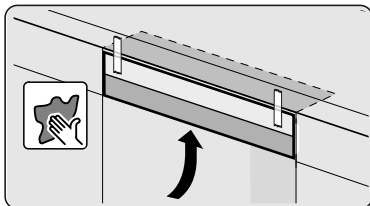
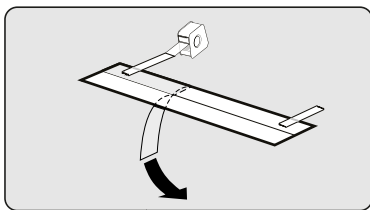

nicht einklemmen  
do not pinch  
ne pas coincer  
No doblar

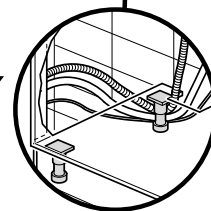



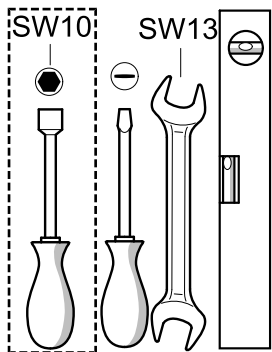
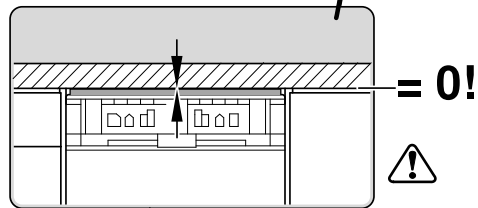
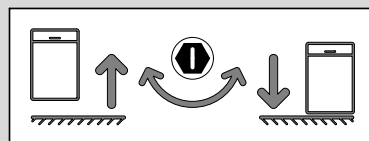
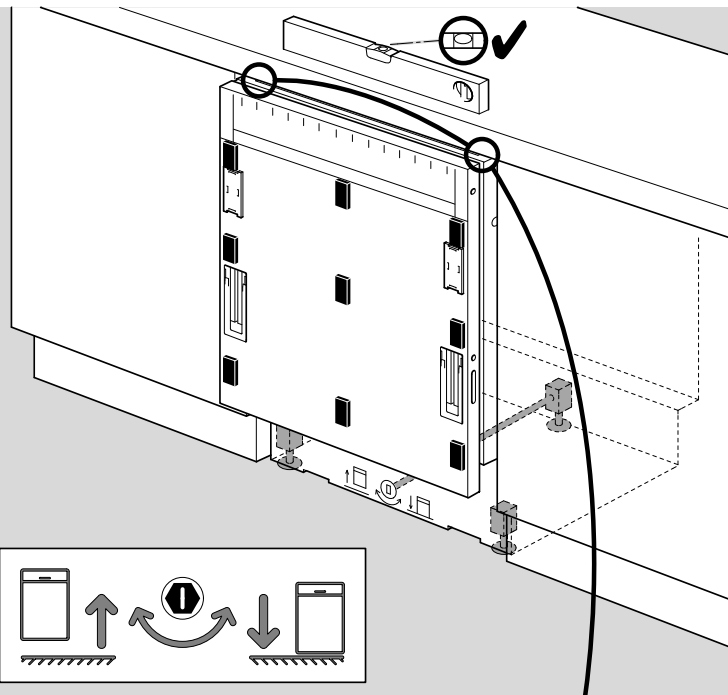
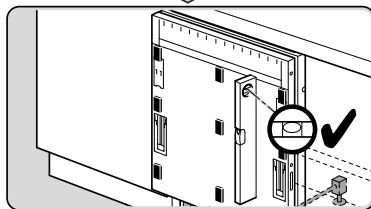
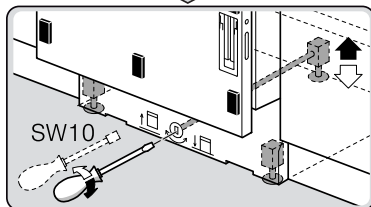
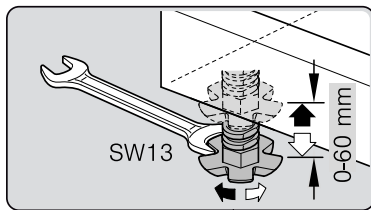

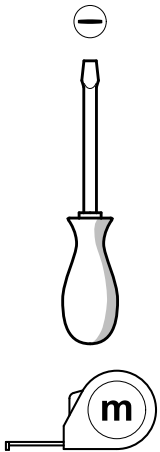
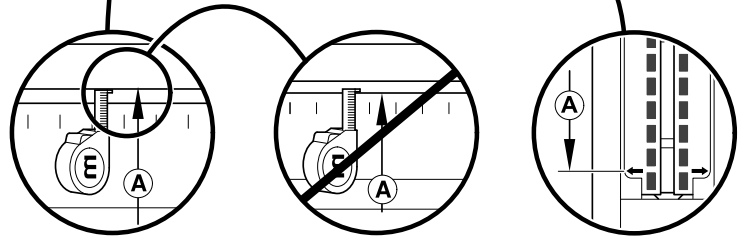
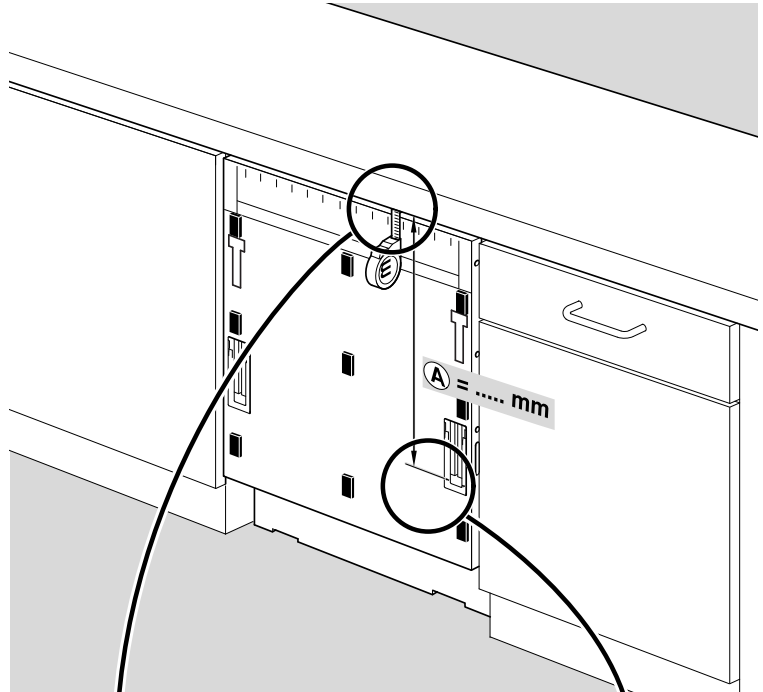
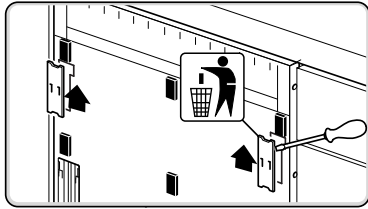

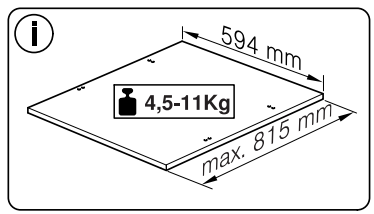
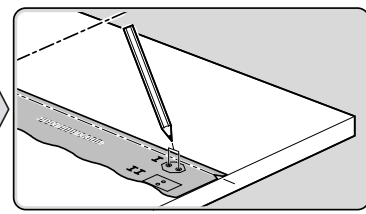
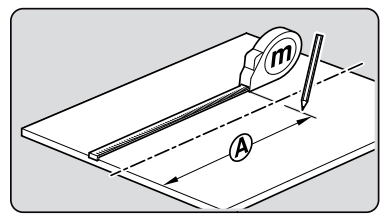
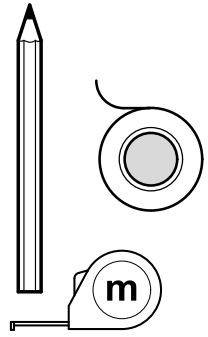
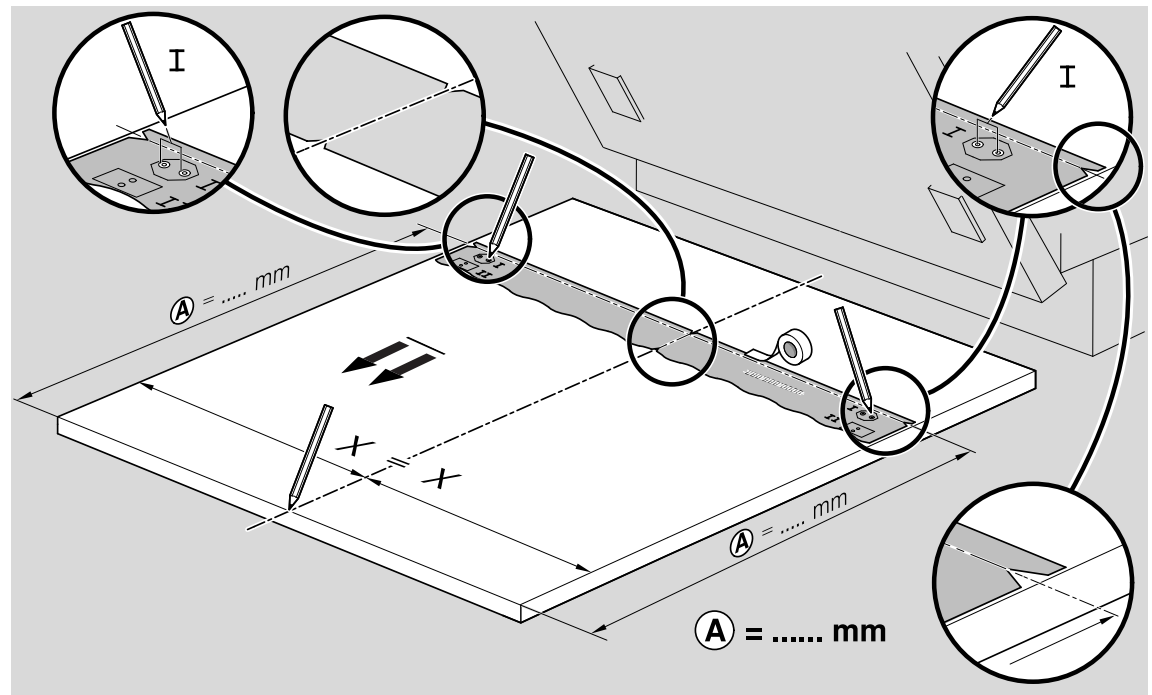
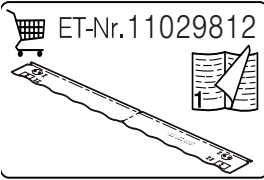
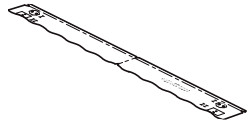

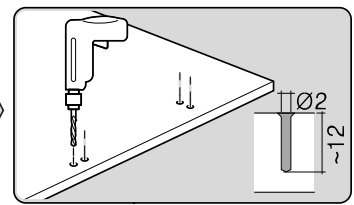
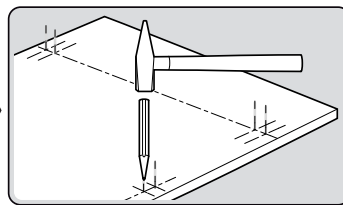
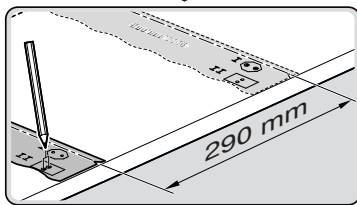
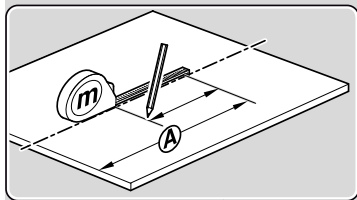
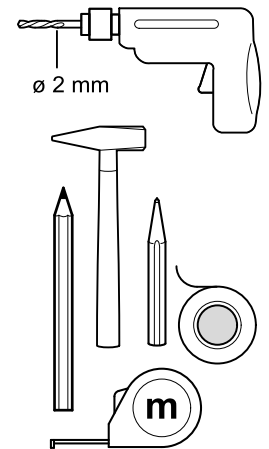
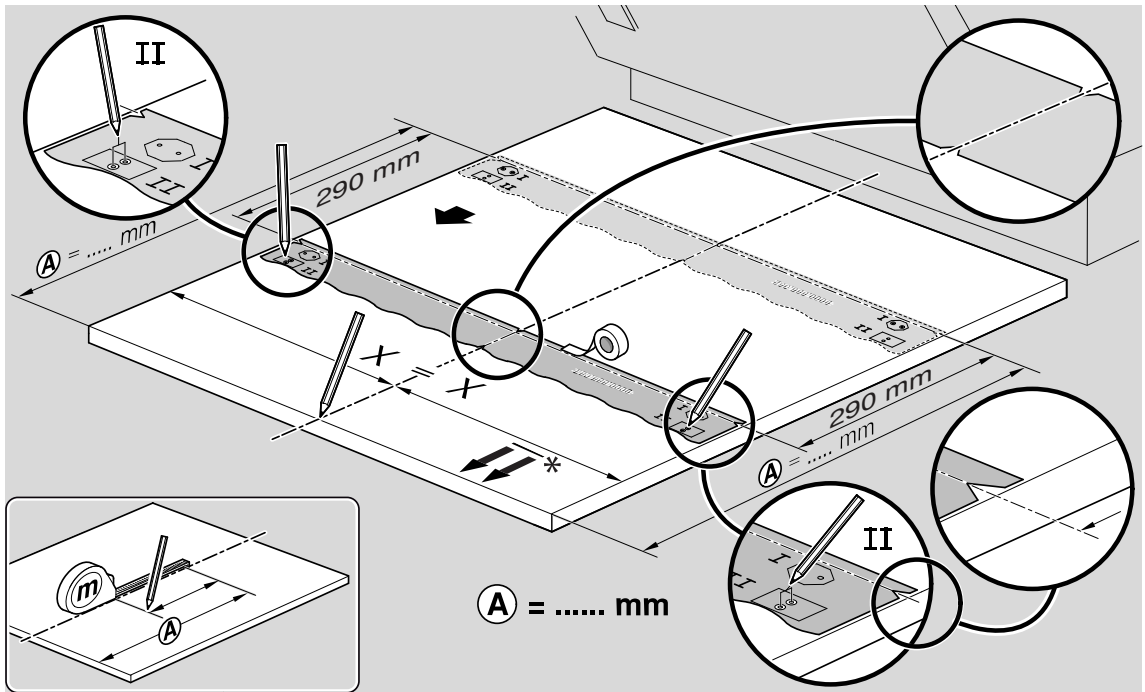
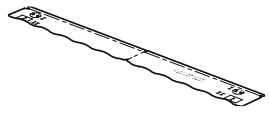

Ø4X15

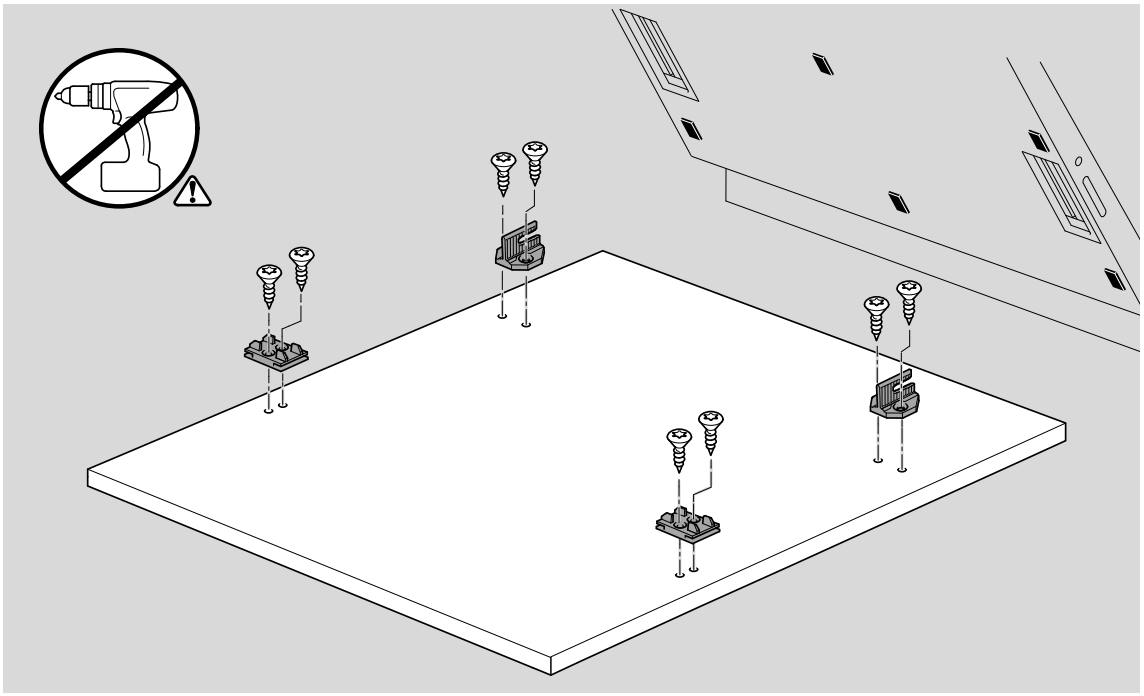
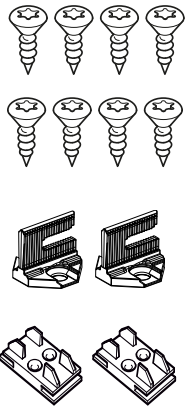

Torx  
T 20

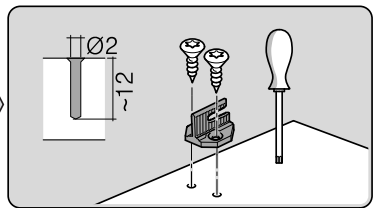
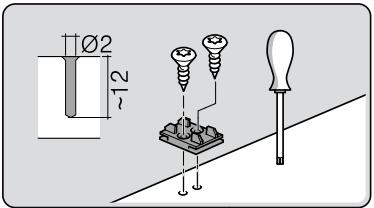
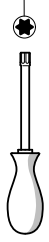

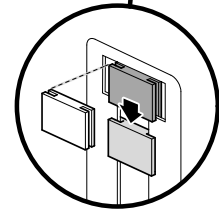
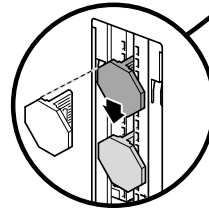
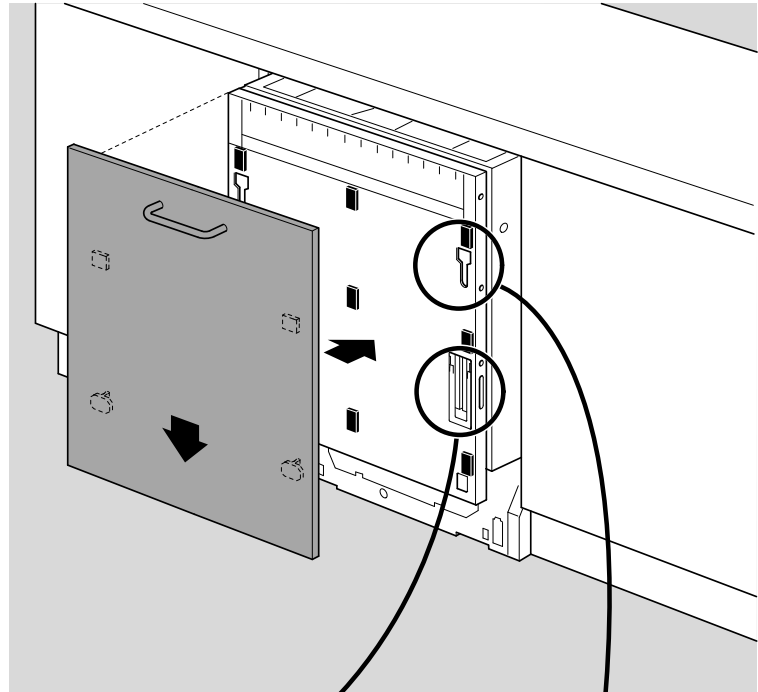
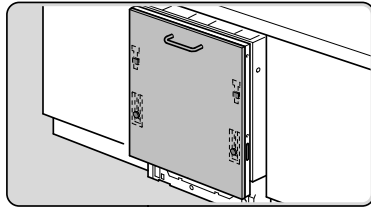
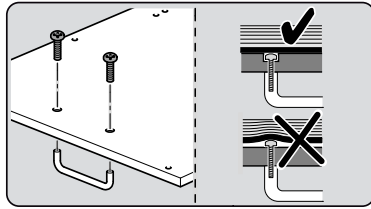

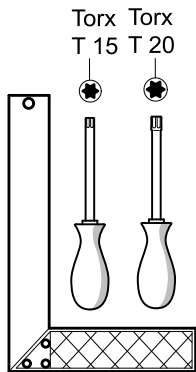
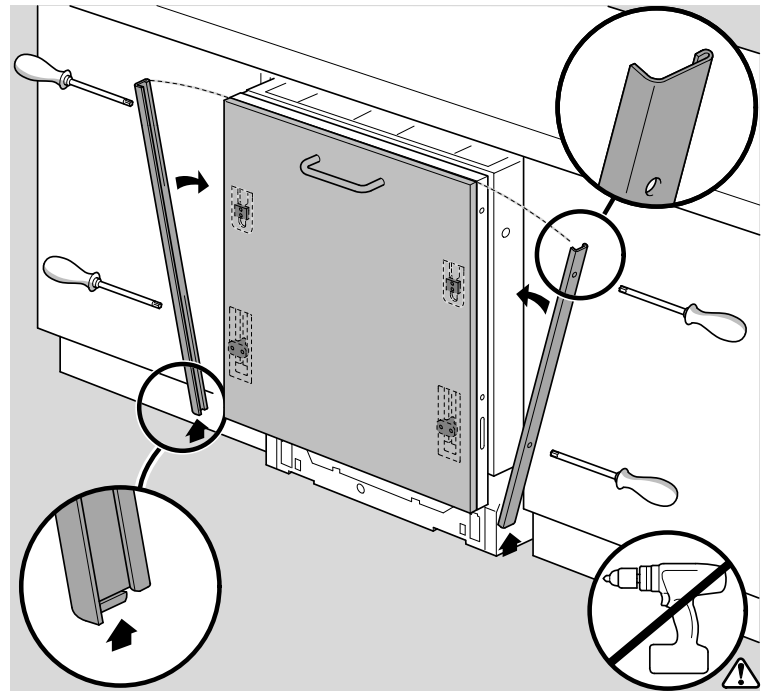
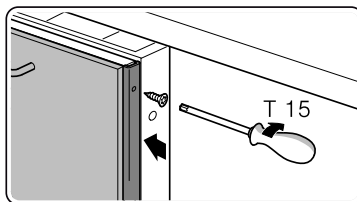
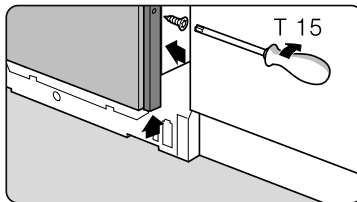
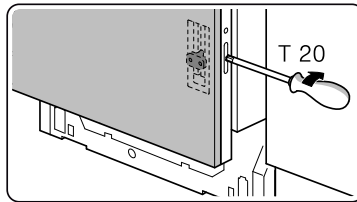
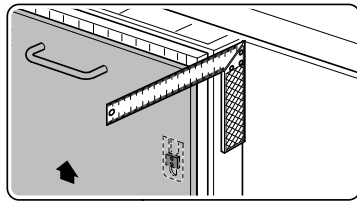

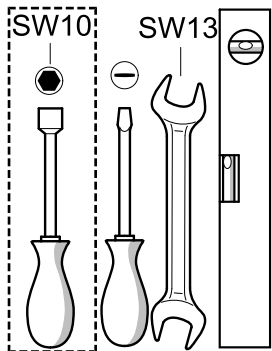
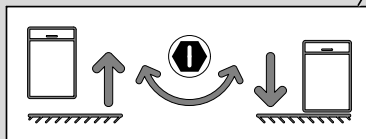
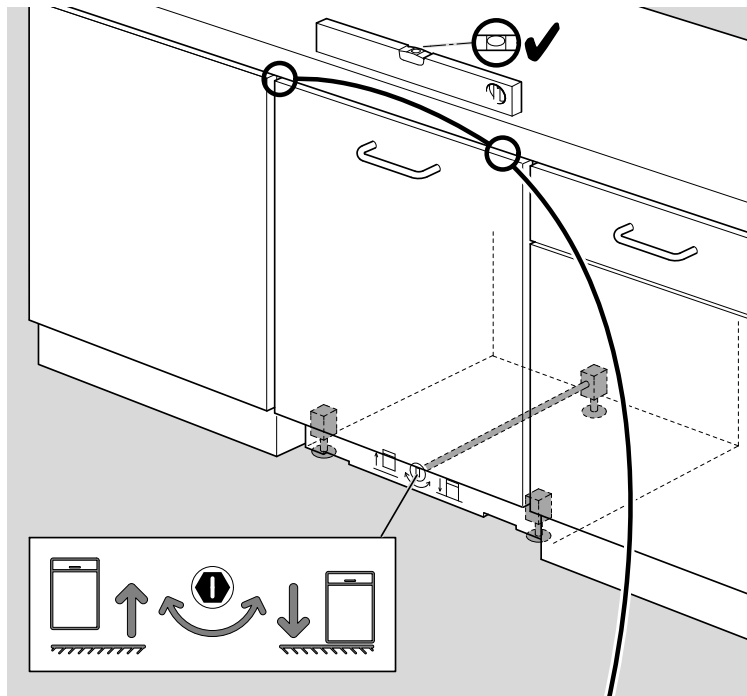
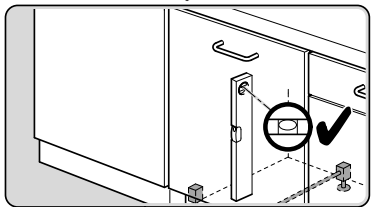
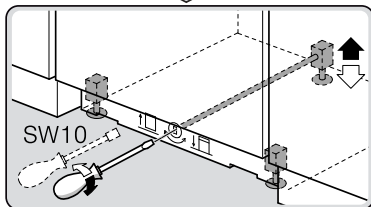
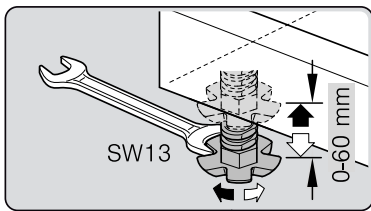

**verspannen**  
**brace**  
**calar verticalement**  
**Enrasar**

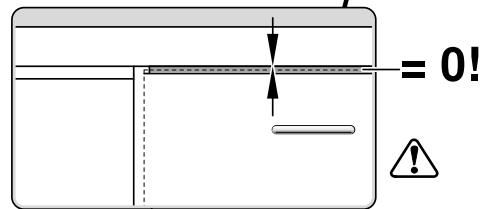



Ø4X36

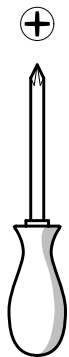
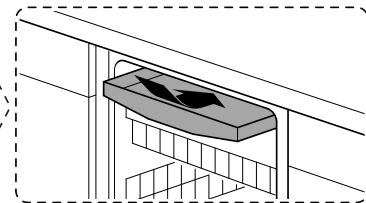
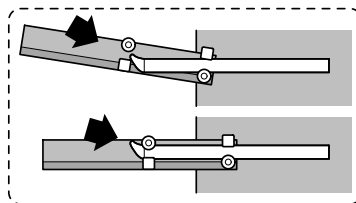
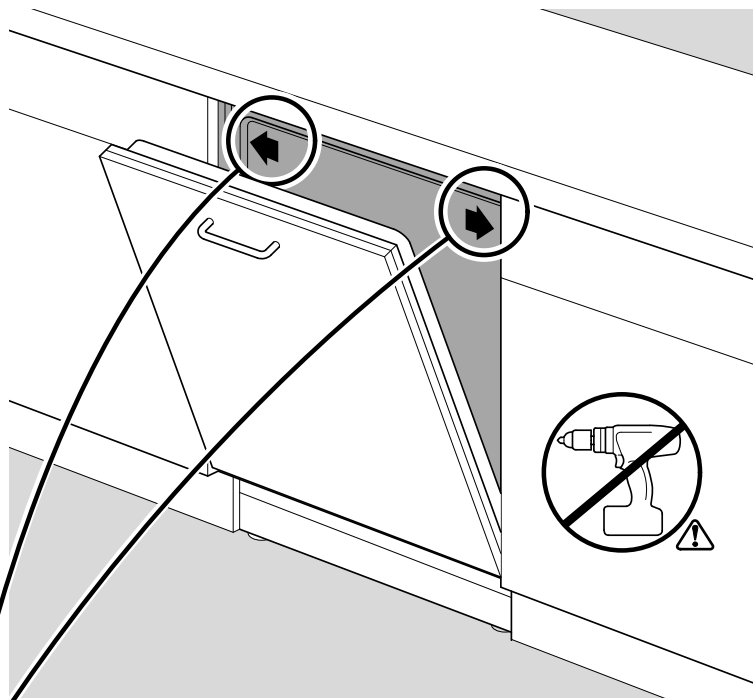
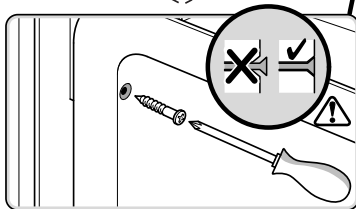
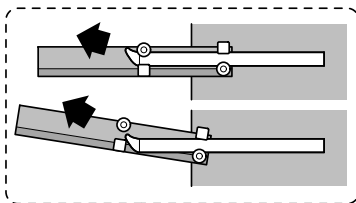
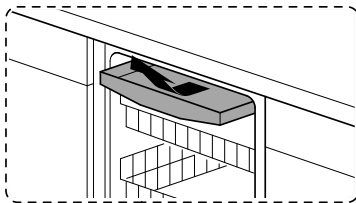
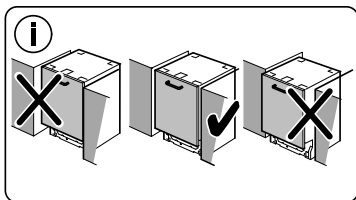
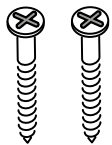

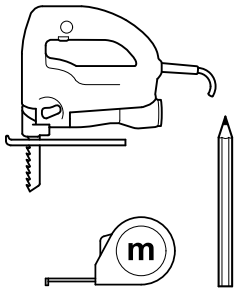
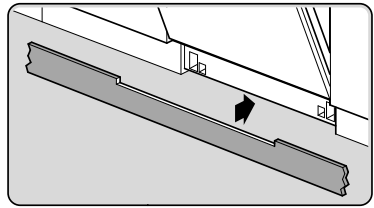
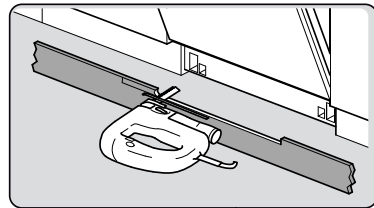
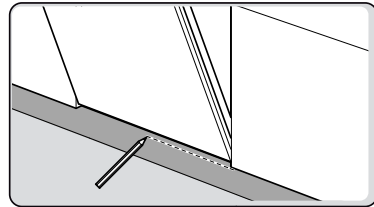
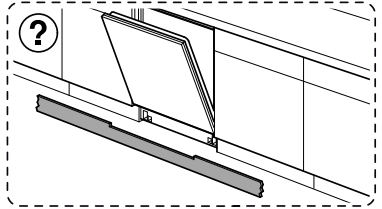
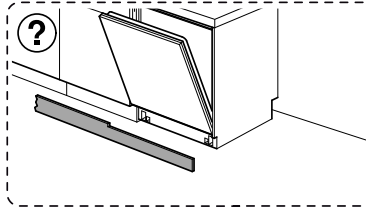
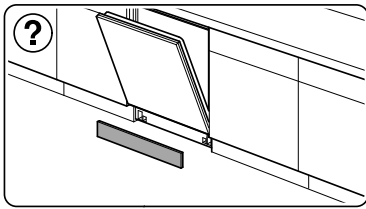

Ø4X15

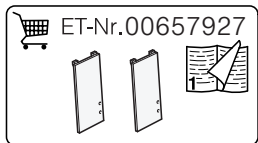
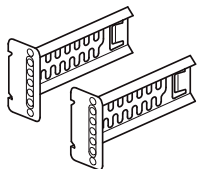

Torx  
T 20

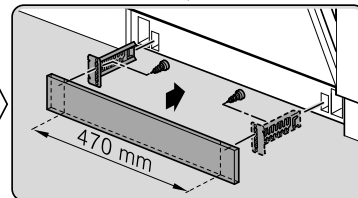
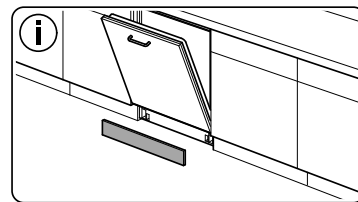
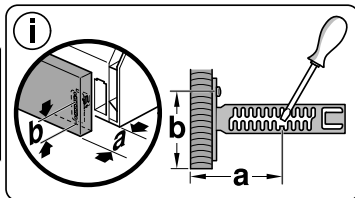
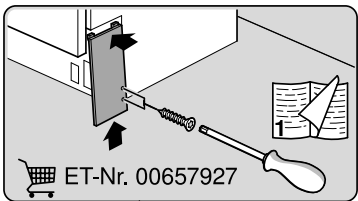
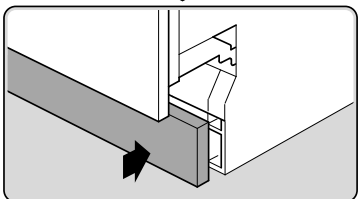
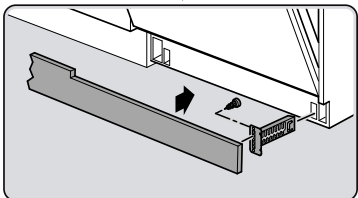
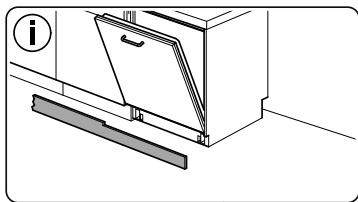
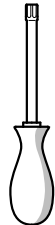

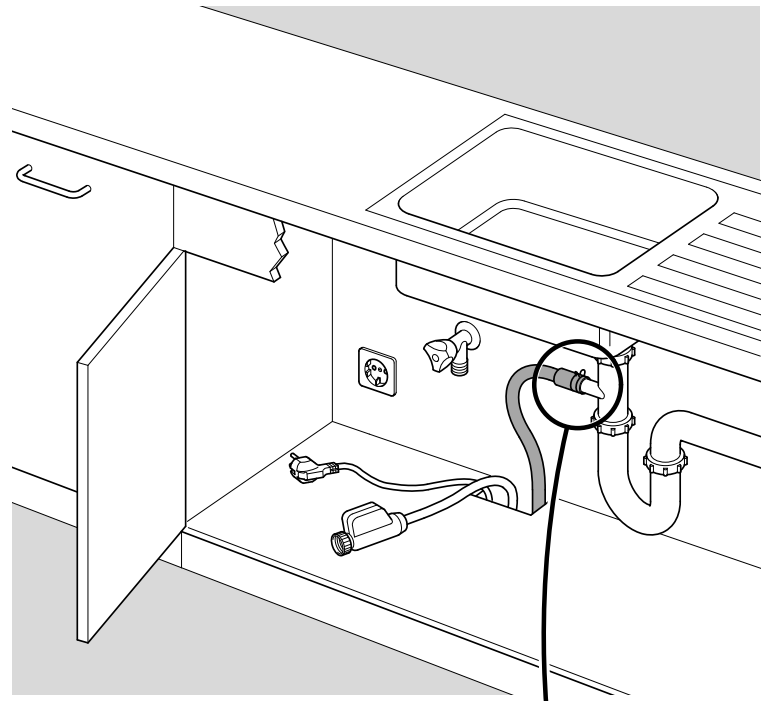
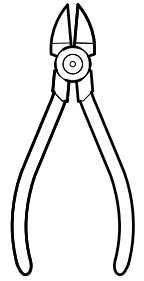
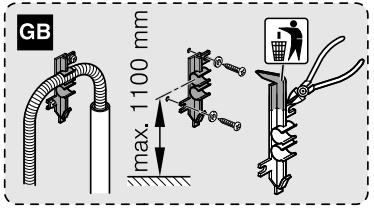
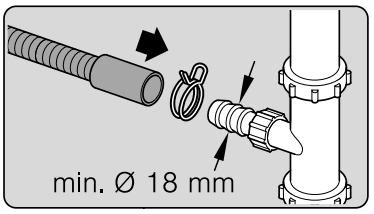
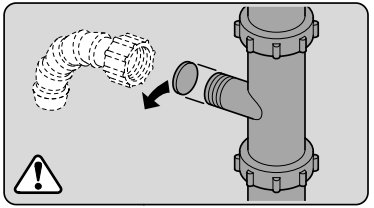
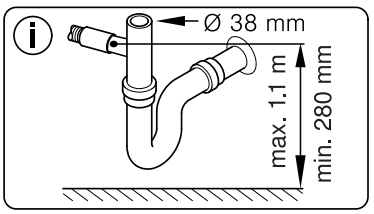

**Dichtheit prüfen**  
**Check for leaks**  
**Verifiez l'étanchéité**  
**Verificar la estanqueidad**



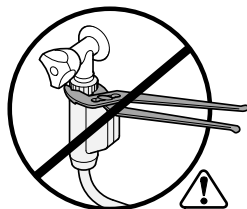
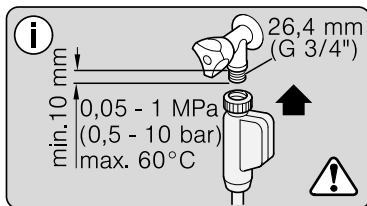

**max. 10 Nm**

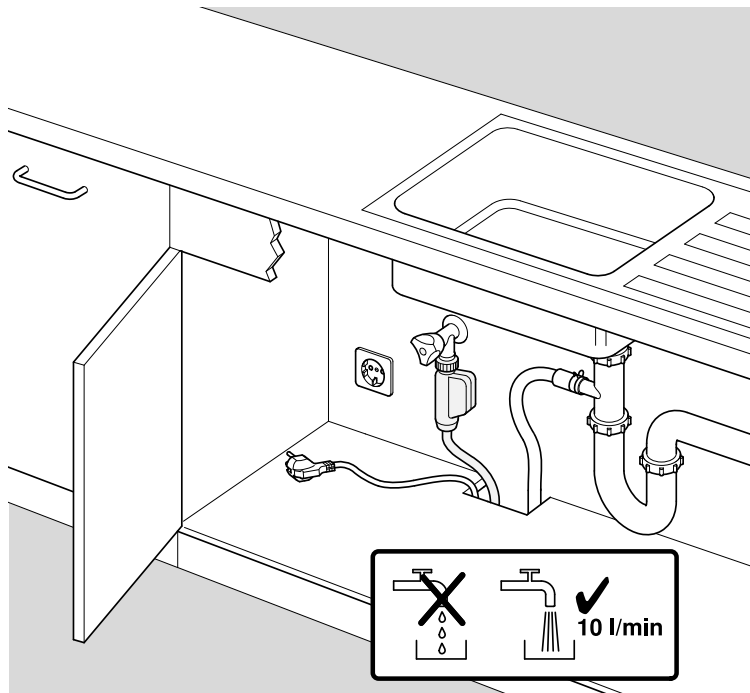

**Dichtheit prüfen**  
**Check for leaks**  
**Verifiez l'étanchéité**  
**Verificar la estanqueidad**



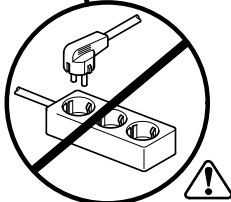
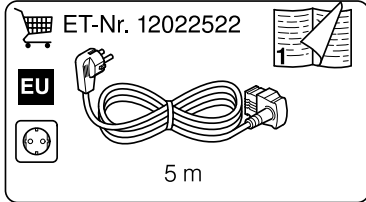
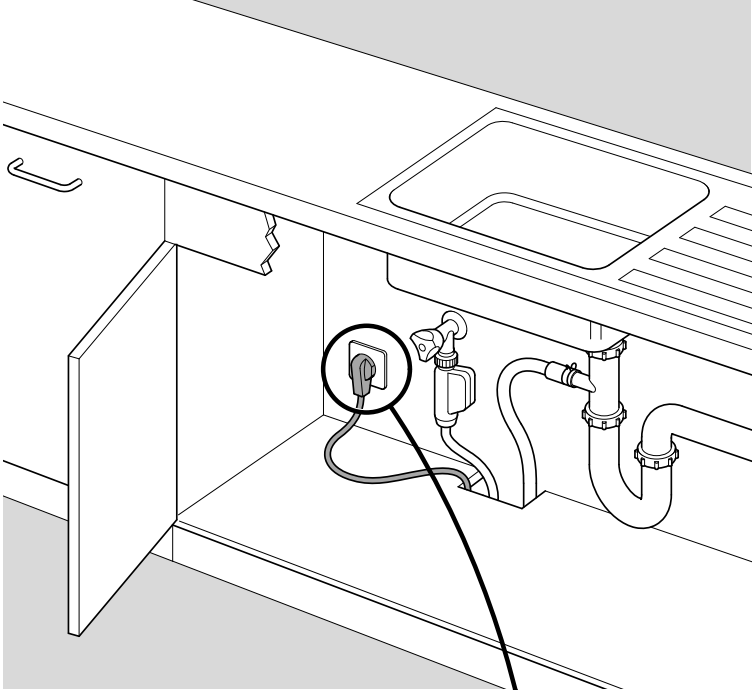
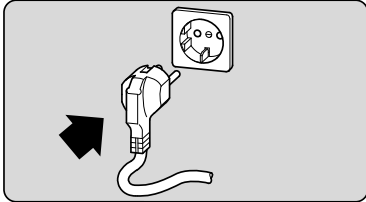



A series of horizontal lines for writing, starting from the top of the page and extending to the bottom, with a vertical margin line on the left side.

