

TR103IBL2

Categorie fornuis	100x60 cm
Aantal ovens met energielabel	2
Cavity heat source	Elektrisch
Type kookplaat	Inductie
Type primaire oven	Thermogeventileerd
Type secundaire oven	Thermogeventileerd
Reinigingssysteem primaire oven	Vapor Clean
EAN-code	8017709312404
Energie-efficiëntieklasse	A
Energie-efficiëntieklasse, tweede oven	B



Design



Esthetiek	Victoria	Bedieningsknoppen	Smeg Victoria
Design	Victoria	Kleur knoppen	Roestvrij staal
Kleur	Zwart	Aantal bedieningsknoppen	9
Afwerking	Glanzend zwart	Kleur serigrafie	Zilver
Afwerking bedieningspaneel	Gekleurd plaatstaal	Display	Elektronisch 5 toetsen
Logo	assembled 50's	Deur	Met kader
Positie logo	Upstand+ Bedieningspaneel	Type glas	Zwart
Upstand	Ja	Handgreep	Smeg Victoria
Kleur kookplaat	Zwart glanzend	Kleur handgreep	Geborsteld roestvrijstaal
Type bediening	Bedieningsknoppen	Plint	Antraciet

Programma's / functies

Aantal kookfuncties 6

Traditionele kookfuncties

Fan assisted base + Vapor clean



Statisch



Geventileerd



Circulaire



ECO

Overige functies



Ontdooien op tijd

Schoonmaak functie

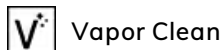

Programma's / functies secundaire oven

Kookfuncties ovenruimte 2 1
 Traditionele kookfuncties, ovenruimte 2



Programma's / functies derde oven

Aantal functies derde oven 1
 Licht 
 Grote vlakgrill 

Technische specificaties kookplaat

Totaal aantal kookzones 5
 Linksvoor - Inductie - enkel - 1.30 kW - Booster 1.40 kW - - Ø 21.0 cm
 Linksachter - Inductie - enkel - 2.30 kW - Booster 3.00 kW - - Ø 18.0 cm
 Midden - Inductie - enkel - 2.30 kW - Booster 3.00 kW - - Ø 27.0 cm
 Rechtsachter - Inductie - enkel - 1.30 kW - Booster 1.40 kW - - Ø 18.0 cm
 Rechtsvoor - Inductie - enkel - 2.30 kW - Booster 3.00 kW - - Ø 21.0 cm

Technische specificaties primaire oven



Aantal lampen	1	Uitneembare ovendeur	Ja
Aantal ventilatoren	1	Volledig glazen binnendeur	Ja
Netto inhoud	61 l	Aantal ruiten ovendeur	3
Bruto inhoud 1e oven	70 l	Aantal thermo-reflecterende ruiten	1
Materiaal ovenruimte	Ever Clean emaille	Veiligheidsthermostaat	Ja
Aantal kookniveaus	4	Koelsysteem	Mantelkoeling
Type ovenrekken	Metalen zijsteunen	Afmetingen bruikbare interne ovenruimte (hxbxd)	316x460x412 mm
Soort verlichting	Halogeen	Temperatuurregeling	Elektro-mechanisch
Vermogen lamp	40 W	Onderwarmte - vermogen	1200 W
Instelling kooktijd	Start en stop	Bovenwarmte - vermogen	1000 W
Deur openen	Side opening	Circulatie - vermogen	2000 W

Opties primaire oven

Timer	Ja	Minimum temperatuur	50 °C
Akoestisch signaal einde kooktijd	Ja	Maximum temperatuur	250 °C

Technische specificaties secundaire oven



Aantal ventilatoren	2	Uitneembare ovendeur	Ja
Netto inhoud (l) oven 2	84 l	Volledig glazen binnendeur	Ja
Bruto inhoud, 2e oven	94 l	Uitneembaar glas binnendeur	Ja
Materiaal ovenruimte	Ever Clean emaille	Aantal ruiten ovendeur	2
Aantal kookniveaus	9	Aantal thermo- reflecterende ruiten	1
Type ovenrekken	Metalen zijsteunen	Veiligheidsthermostaat	Ja
Aantal lampen	1	Koelsysteem	Mantelkoeling
Soort verlichting	Halogeen	Afmetingen bruikbare interne ovenruimte (hxbxd)	605x375x375 mm
Vermogen lamp	40 W	Temperatuurregeling	Elektro-mechanisch
Deur openen	Side opening	Circulatie - vermogen	2 x 1550 W

Opties secundaire oven

Minimum temperatuur	50 °C	Maximum temperatuur	245 °C
---------------------	-------	---------------------	--------

Technische specificaties derde oven



Netto inhoud (l) oven 3	36 l	Uitneembaar glas binnendeur	Ja
Bruto inhoud, 3e oven	41 l	Aantal ruiten ovendeur	3
Materiaal ovenruimte	Ever Clean emaille	Aantal thermo- reflecterende ruiten	1
Aantal kookniveaus	2	Veiligheidsthermostaat	Ja
Type ovenrekken	Metalen zijsteunen	Koelsysteem	Mantelkoeling
Aantal lampen	1	Afmetingen bruikbare interne ovenruimte (hxbxd)	169x440x443 mm
Soort verlichting	Halogeen	Temperatuurregeling	Elektro-mechanisch
Vermogen lamp	40 W	Grote vlakgrill - vermogen	2700 W
Deur openen	naar beneden	Type grill	Elektrisch
Uitneembare ovendeur	Ja	Kantelbare grill	Ja
Volledig glazen binnendeur	Ja		

Opties derde oven

Minimum temperatuur 50 °C

Maximum temperatuur 260 °C

Meegeleverde accessoires primaire oven en kookplaat



Rek met achter- en zijstop 2
Bakplaat (40 mm) 1

Inzetrooster 1
Telescopische geleiders, gedeeltelijk uitschuifbaar 1

Meegeleverde accessoires secundaire oven



Ovenrooster met stop 4

Bordenwarmhouder 1

Meegeleverde accessoires derde oven

Rek met achter- en zijstop 1

Bakplaat (40 mm) 1

Elektrische aansluiting

Aansluitwaarde 15400 W
Stroom 43 A
Spanning 220-240 V
Spanning 2 (V) 380-415 V
Electric cable Installed, Single phase

Lengte voedingskabel 150 cm
Type stroomkabel Double and Three Phase
Frequentie 50/60 Hz
Aansluitkast 5 polig

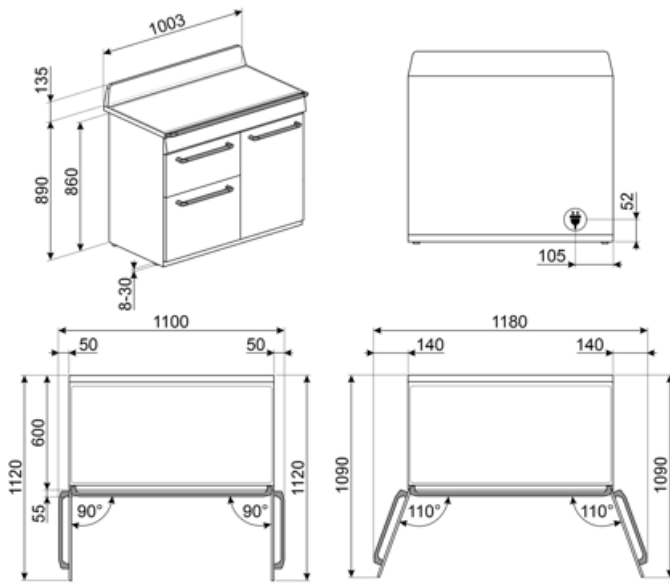

Accessoires niet inbegrepen

AIRFRY

Airfryerrek AIRFRY . Ideaal voor traditioneel frituren in de oven, maar met minder calorieën en minder vet. Hiermee creëer je snel en eenvoudig gerechten zoals frites, gebakken groenten en vis, waardoor ze perfect bruin en krokant worden.



BN620-1

Geëmailleerde bakplaat, 20 mm diep



BNP608T

Teflon-coated tray, 8mm depth, to be placed on the grid



GTP

Gedeeltelijk uittrekbare telescopische geleiders (1 niveau)



KIT1TR103

Splashback black, 100cm ,suitable for TR103 Victoria cookers



PALPZ

Pizzaschep met inklapbare handgreep breedte: 315 mm lengte: 325 mm



SFLK1

Kinderslot



TPKPLATE

Universal plate for induction, gas, ceramic and electric hobs. Non-stick surface ideal for cooking fish, eggs and vegetables. Dimensions: 410 X 240 mm.



BBQ

Dubbelzijdig



BN640

Geëmailleerde bakplaat, 40 mm diep



GRILLPLATE

Universal griddle for induction, gas, ceramic and electric hobs. Non-stick surface ideal for cooking meat, cheese and vegetables. Dimensions: 410 x 240 mm.



GTT

Volledig uittrekbare telescopische geleiders (1 niveau)



KITH103

Height extension kit (950 mm), black, suitable for TR103 cookers (945-960mm)



SCRP

Inductie- en keramische kookplaten en teppanyaki-schraper







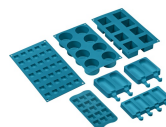

























SMOLD

Set van 7 siliconen vormpjes voor ijsjes, ijslolly's, pralines, ijsblokjes of om etenswaren te portioneren. Bruikbaar van -60 ° C tot + 230 ° C



Symbols glossary

 <p>Kinderslot: sommige modellen zijn voorzien van een apparaat om het programma / de cyclus te vergrendelen zodat het niet kan per ongeluk veranderd</p>	 <p>A: Droogprestaties van het product, gemeten vanaf A +++ tot D / G afhankelijk van de productfamilie</p>
 <p>Installation in column: Installation in column</p>	 <p>Luchtkoelsysteem: om een veilig oppervlak te garanderen temperaturen.</p>
 <p>B: Energieklasse van het product, gemeten van A +++ tot D / G, afhankelijk van de productfamilie.</p>	 <p>Ontdooien op tijd: met deze functie wordt automatisch het tijdstip van ontdooien van voedsel bepaald</p>
 <p>Dubbele beglazing: aantal glazen deuren.</p>	 <p>Deuren met driedubbele beglazing: aantal glazen deuren.</p>
 <p>ECO-logic: optie stelt u in staat om de vermogenslimiet van de werkelijke energiebesparing van het apparaat te beperken</p>	 <p>Geëmailleerde binnenkant: De geëmailleerde binnenkant van alle Smeg-ovens heeft een speciale antacidumvoering die helpt om de binnenkant schoon te houden door de hoeveelheid kookvet te verminderen.</p>
 <p>Ventilator met bovenste en onderste elementen: de elementen in combinatie met de ventilator zijn bedoeld om een meer gelijkmatige warmte te bieden, een methode die vergelijkbaar is met conventioneel koken, dus voorverwarmen is vereist. Het meest geschikt voor items die langzaam koken vereisen.</p>	 <p>De ovenruimte wordt tegelijk door het onder- en bovenelement verwarmt. De hitteverdeling over het gerecht is afhankelijk van het niveau waarop men dit plaatst. Geschikt voor bakken op 1 niveau. Gerechten: alle ovenschotels, vlees, gevogelte, brood, (gevulde) taarten. Speciaal: gans en eend (bevatten veel vet).</p>
 <p>Circulaire: it is the perfect function for cooking all types of dishes in a more delicate way. The heat comes from the back of the oven and is distributed quickly and evenly The fan is active. It is also ideal for cooking on multiple levels without mixing smells and flavors.</p>	 <p>ECO: low energy consumption cooking: this function is particularly suitable for cooking on a single shelf with low energy consumption. It is recommended for all types of food except those that can generate a lot of moisture (for example vegetables). To achieve maximum energy savings and reduce time, it is recommended to put the food in the oven without preheating the cooking compartment</p>
 <p>De warmte wordt geproduceerd door het grill- en bovenelement. Verhitting over het volledige oppervlak. De thermostaat wordt, afhankelijk van het gerecht, in de regel op de maximale stand gezet. Bij een korte baktijd kan de ovendeur gesloten blijven; bij langere baktijd blijft deze gedeeltelijk geopend. Voor vleesgerechten (klein- en middelgroot), vleespennen, vis, groenten, gratineren etc.</p>	 <p>Light</p>
 <p>Induction: The work of these hobs is based on the principle of electromagnetic induction. The heat is generated directly in the bottom of the pan during its contact with the hob.</p>	 <p>All glass inner door: All glass inner door, a single flat surface which is simple to keep clean.</p>

-
-  verlichting
 -  Plate rack warming: function for heating or keeping dishes warm. Place the baking tray on the lowest shelf and stack the dishes to be heated.
 -  The oven cavity has 2 different cooking levels.
 -  The oven cavity has 4 different cooking levels.
 -  The oven cavity has 9 different cooking levels.
 -  Telescopic rails: allow you to pull out the dish and check it without having to remove it from the oven entirely.
 -  Electronic control: Allows you to maintain temperature inside the oven with the precision 2-3 ° C. This enables to cook meals that are very sensitive to temperature changes, such as cakes, souffles, puddings.
 -  Tilting grill: the tilting grill can be easily unhooked to move the heating element and clean the roof of the appliance in one simple step.
 -  Vapor Clean: a simple cleaning function using steam to loosen deposits in the oven cavity.
 -  The capacity indicates the amount of usable space in the oven cavity in litres.
 -  The capacity indicates the amount of usable space in the oven cavity in litres.
 -  The capacity indicates the amount of usable space in the oven cavity in litres.
 -  Knobs control

Benefit (TT)

True-convection

The best cooking performances guaranteed by ventilated circular flow

Multiple fans and heating elements guarantee the perfect aerodynamic heat flow, allowing homogeneous and quicker cooking inside the cavity.

Induction hob

Induction offers fast cooking and precise temperature control

Through the use of suitable cookware, induction is easy to use and maintain, safe and responsive.

Vapor Clean

By inserting water into a recess at the bottom of the cavity, steam is generated, which softens the residue and facilitates its removal

By inserting water into a recess at the bottom of the cavity, steam is generated, which softens the residue and facilitates its removal.

Single turbine

The oven has a fan equipped with a circular heating element allowing cooking with rotating heat

Isothermic Cavity

The best cooking performance at the highest energy efficiency

Tangential cooling

New cooling system with tangential fan and airflow from the door to the splashback

Multilevel halogen light

Internal halogen lighting on different levels guarantees excellent visibility

Buttons control

Easy and intuitive timer setting with a simple buttons

Telescopic guides

Easy extraction and safe insertion of trays into the oven thanks to telescopic guides

Adjustable height

Cooker top flushed with the working area thanks to adjustable feet

Multilevel cooking

Several cooking levels allow maximum flexibility of use

Cold door

During any function, the external door glass is cold, avoiding any risk of burns

AirFry (AIRFRY optional accessory)

Lighter and tastier food thanks to airfry basket (optional accessory)

BBQ (optional accessory)

Barbeque cooking directly in the oven with the double-sided grill (BBQ optional accessory)

Pizza stone (optional accessory)

Baking with refractory stone for soft and crispy pizza and yeast products (STONE optional accessory)